

# SEISMIC RETROFITTING GUIDELINES OF BUILDINGS IN NEPAL

# 2013

TRAINING  
CURRICULUM  
(Engineer)

PART I  
PARTICIPANTS'  
WORKBOOK



April 2013

# SEISMIC RETROFITTING GUIDELINES

of

## Buildings in Nepal

TRAINING CURRICULUM  
(Engineer)

PART I  
PARTICIPANT'S WORKBOOK



Empowered lives.  
Resilient nations.



# FOREWORDS

Intentionally Left Blank

# ACKNOWLEDGEMENT

Intentionally Left Blank

## LIST OF ACRONYMS

---

Intentionally Left Blank

## LIST OF FIGURES

<i>Figure 1-1 Value of Seismic Zone (NBC 105) .....</i>	<i>2</i>
<i>Figure 1-2 Step-by-step approach to evaluation, design and construction plan.....</i>	<i>5</i>
<i>Figure 2-1 Irregularity in Plan and Elevation (IS 1893: 2002, details of other irregularities are given in Appendix 1 .....</i>	<i>10</i>
<i>Figure 3-1 Jacketing a concrete column .....</i>	<i>24</i>
<i>Figure 3-2 Introduction of a new shear wall.....</i>	<i>25</i>
<i>Figure 3-3 Introduction of a steel frame in existing RCC frame building.....</i>	<i>25</i>
<i>Figure 3-4 Introduction of dampers in existing RCC structure.....</i>	<i>26</i>
<i>Figure 3-5 Reinforcing masonry/ adobe walls with geo- mesh (source: World Housing Tutorial).....</i>	<i>26</i>
<i>Figure 3-6 Anchorage of slab/ floor with masonry wall.....</i>	<i>27</i>
<i>Figure 4-1 Improper construction sequence led to complete collapse of the structure during retrofitting.....</i>	<i>29</i>
<i>Figure 4-2 Schematic diagram showing stage wise retrofitting of foundation of load bearing masonry walls .....</i>	<i>30</i>

**LIST OF TABLES**

*Table 5-1 General Description of Existing Building* .....38

*Table 5-2 Structural Assessment Checklist*.....39

Intentionally Left Blank



<b>LIST OF ACRONYMS .....</b>	<b>iii</b>
<b>LIST OF FIGURES .....</b>	<b>iv</b>
<b>LIST OF TABLES .....</b>	<b>v</b>
<b>ABSTRACT.....</b>	<b>vi</b>
<b>CONTENTS.....</b>	<b>vii</b>
<b>1. INTRODUCTION .....</b>	<b>1</b>
1.1 SEISMICITY AND INTRODUCTION TO RETROFITTING.....	1
1.2 SEISMICITY AND ZONING FACTORS .....	1
1.3 RETROFITTING: WHY?.....	2
1.4 RETROFITTING: GENERAL CONSIDERATION .....	4
1.5 REALIZATION OF RETROFIT REQUIREMENT .....	4
1.6 SELECTION OF ENGINEER/ARCHITECT .....	4
1.7 NOTIFICATION TO MUNICIPALITY OR CONCERNED AUTHORITY .....	6
1.8 ESTABLISH PERFORMANCE OBJECTIVES OR DESIGN REQUIREMENTS ..	6
1.9 REVIEW EXISTING CONDITION OF BUILDING .....	7
1.10 CARRY OUT VULNERABILITY EVALUATION.....	7
1.11 CARRY OUT PRELIMINARY DESIGN WITH COST ESTIMATE .....	7
1.12 DETAIL DESIGN.....	7
1.13 PREPARE CONSTRUCTION DOCUMENTS AND QUALITY ASSURANCE PLAN 7	
1.14 SUBMISSION TO THE AUTHORITY .....	8
1.15 MONITORING AND QUALITY CONTROL.....	8
<b>2. ANALYTICAL PROCEDURE .....</b>	<b>9</b>
2.1 LINEAR PROCEDURES .....	9
2.2 NONLINEAR PROCEDURES .....	10
2.3 SEISMIC ASSESSMENT AND STRENGTH CHECK .....	11
2.3.1 RAPID ASSESSMENT (VISUAL SURVEY).....	11
2.3.2 DETAILED EVALUATION.....	16
2.4 REQUIRED PERFORMANCE LEVEL .....	21
2.4.1 STRUCTURAL ELEMENTS.....	21

2.4.2	NON STRUCTURAL ELEMENTS .....	22
<b>3.</b>	<b>RETROFITTING TECHNIQUES .....</b>	<b>23</b>
<b>4.</b>	<b>CONSTRUCTION TECHNOLOGY AND QUALITY CONTROL.....</b>	<b>28</b>
4.1	REPAIR OF FOUNDATION .....	30
4.2	REPAIR OF COLUMN .....	32
4.3	REPAIR OF BEAM.....	34
4.4	REPAIR OF WALL.....	35
4.5	QUALITY CONTROL .....	36
<b>5.</b>	<b>SAMPLE EXAMPLE PROBLEM .....</b>	<b>38</b>
	ANALYSIS AS RESIDENTIAL BUILDING :.....	44
	ANALYSIS AS HEALTH CLINIC:.....	49
	RETROFITTING DRAWINGS: .....	59
	<b>APPENDIX I .....</b>	<b>63</b>
	<b>IRREGULARITIES IN BUILDINGS WHICH RESTRICT USE OF STATIC</b>	
	<b>PROCEDURE FOR ANALYSIS .....</b>	<b>63</b>

# 1. INTRODUCTION

---

## 1.1 SEISMICITY AND INTRODUCTION TO RETROFITTING

Nepal, because of its location in the boundary of two active tectonic plates moving against each other, is in high earthquake hazard zone. Majority of the buildings, including in the capital Kathmandu, are constructed without proper seismic consideration which has increased the vulnerability. The ground in Kathmandu has mostly soft soil which further amplifies the earthquake hazard. The earthquake risk is further amplified by the fact that Kathmandu, and other part of the country as well, is ill prepared to deal the emergency situation. Different studies undertaken in the past have underscored the fact that Kathmandu is one of the most vulnerable cities in terms of earthquake risk.

A study under Global Earthquake Safety Initiative (GESI) carried out vulnerability survey of 21 cities around the world - including Kathmandu. The results suggest that Kathmandu has the lowest performance among all the cities considered. The risk of mortality from damaged or collapsed buildings in Kathmandu is extremely high. The evaluation of fire fighting preparedness, medical care preparedness and general preparedness reveals a very low disaster response capability<sup>1</sup>. The severity in the aftermath of a major earthquake will be of catastrophic consequences for Kathmandu as underscored in a study by the government that "once a great earthquake occurs, Kathmandu will suffer immense losses of life and property and will be unlikely to be able to function as the capital of Nepal<sup>2</sup>."

## 1.2 SEISMICITY AND ZONING FACTORS

Nepal has a long history of destructive earthquakes and the seismic record shows that major earthquakes strike the region in every 75-100 years period. The oldest record available of

---

<sup>1</sup> Global Earthquake Safety Initiatives (GESI), Geo-Hazard International and UNCRD, 2001

<sup>2</sup> Ministry of Home Affairs, JICA, 2002

major earthquake dates back to 1255 AD. Three major earthquakes occurred in Kathmandu valley in the 19th century in 1810, 1833 and 1866 AD. These earthquakes have devastated Kathmandu time and again by claiming lives and livelihoods of thousands of people. The earthquake that occurred in 1255 not only killed one third of the population of the city but also killed the then incumbent king – Abhaya Malla. Another earthquake in 1934 AD, believed to be above 8 in Richter scale, wreaked heavy damage not only in Kathmandu but also throughout the country. Nepal experienced another large earthquake in 1988 which was measured 6.2 in Richter scale. Although there was no major damage in Kathmandu, the 1988 earthquake killed 721 people and damaged more than 60,000 buildings.

The seismic zoning factor developed for NBC is shown in the figure below

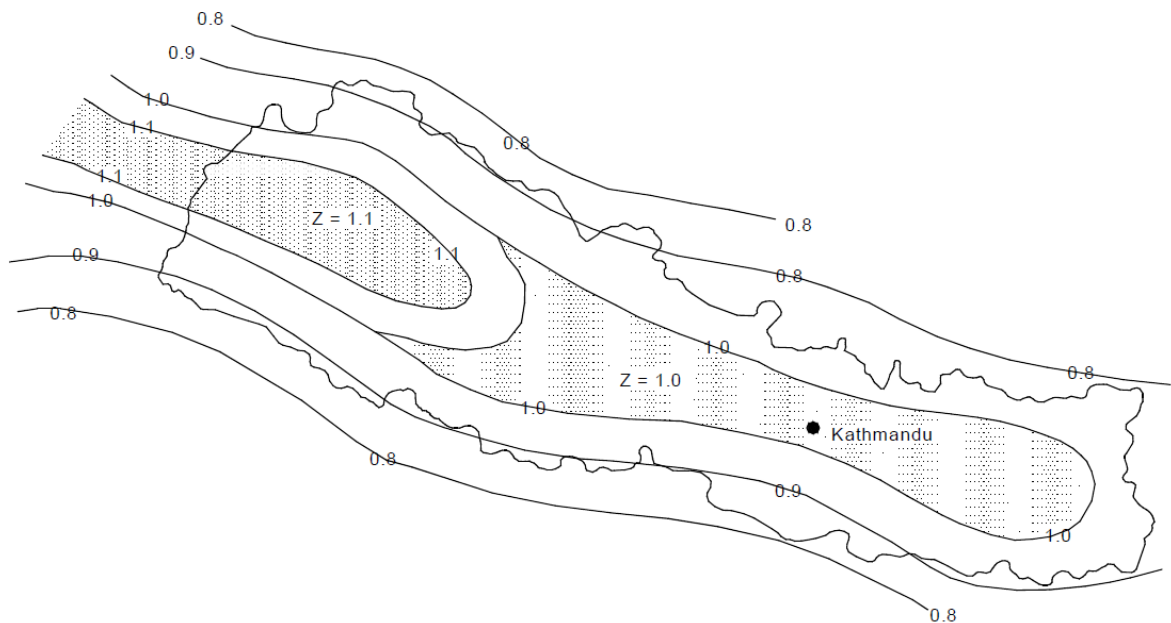

Figure 1-1 Value of Seismic Zone (NBC 105)

### 1.3 RETROFITTING: WHY?

Nepal lies in high seismic risk zone because of its location in the boundary of two colliding tectonic plates - Indian plate and Eurasian plate. Because of the location, Nepal experiences frequent minor earthquakes and occasional earthquakes, in an average span of 75-100 years, of very high magnitude. The country is not only highly seismic zone, but also has buildings and infrastructure constructed without proper adherence to seismic safety standards which make them vulnerable. Nepal has experienced many major earthquakes in the past with devastating consequences.

The country in the last few decades has witnessed a rapid growth in urban population as urban centers have been flooded with large influx of people. The growth in urban population has resulted in rapid urbanization with increase in construction of buildings and infrastructure. Although building code was promulgated in 2004, most of the buildings constructed in the country seldom meet the requirements of the building code. The likelihood of a significant earthquake hazard in Nepal coupled with vulnerable buildings and infrastructures have rendered the country as one of the most 'at risk' countries in terms of earthquake risk. The last earthquake of 1934 had substantial damage in Kathmandu and eastern Nepal. In an earthquake of similar magnitude, "Kathmandu will suffer immense losses of life and property and will be unlikely to be able to function as the capital of Nepal<sup>3</sup>."

Although many rural constructions still follow the traditional methods of construction using timber and adobe (Kacha), the recent trend of building construction in urban areas follows construction using cement and bricks (Pakka). Pakka construction usually follows either framed construction (beam-column with brick walls as infill walls) or load bearing construction (using cement brick walls as major structural element). The philosophy of design and construction of Pakka house is that they should be able to resist certain level of earthquake forces through their strength and should be able to deform in a ductile fashion without collapse in case of major earthquake. The strength consideration is met with proper sizing of members such as columns or walls and the ductile requirement is met through detailing provisions in the buildings. Most of the buildings constructed in Nepal meet neither the strength nor follow ductility requirements as envisaged in building codes. Unfortunately, even the building constructed after promulgation of the building code in 2004 do not meet the requirements of a earthquake safer building as laid out in building codes. Although a detailed study of vulnerability of the buildings is already over due, it's pointed out that more than two-thirds of building, including those in the capital city of Kathmandu, are not safe in case of a major earthquake.

Although some of the buildings may require demolition and reconstruction due to their very poor existing condition, it is not only impractical but also not advisable to demolish these existing buildings. In order to ensure that the buildings are safe or meet capacity requirement, it is essential that the structural capacity of the buildings should be enhanced by retrofitting.

---

<sup>3</sup> MOHA, JICA (2002)

For the buildings which are vulnerable in earthquakes but can be upgraded to meet earthquake safety requirements by structural intervention at reasonable cost, retrofitting is recommended. Many of the recently constructed buildings in urban areas like Kathmandu and in other parts of the country as well have structural deficiencies which can be strengthened using retrofitting techniques.

#### **1.4 RETROFITTING: GENERAL CONSIDERATION**

The process of seismic evaluation and retrofit is a risk reduction process and owners must understand that the process aims to balance the relative risk rather than transferring risk to design professionals and/or contractors and ‘guaranteed’ performance may not always be achievable.

A recommended step-by-step process to realize retrofitting is given in Figure 2. The process shall serve only as guideline and depending upon the scope and size of the project, few steps from the process may be skipped or few additional steps may be added.

#### **1.5 REALIZATION OF RETROFIT REQUIREMENT**

The purpose of retrofitting shall be established before proceeding for rehabilitation, strengthening or retrofitting of a building. Retrofitting may be required from any of the following reasons:

1. Codal requirements to meet the prescribed requirements in NNBC 105 and other relevant codes.
2. Change in use such as conversion of residential building to a school building
3. Functional change such as requirement of a large conference room or addition of floors not included in the previous design
4. Upgrading performance of the building

#### **1.6 SELECTION OF ENGINEER/ARCHITECT**

To execute retrofit project qualified structural engineer or Architect with sufficient knowledge and experience in retrofit design or both are required. As retrofitting works require competency not only in regular structural engineering practices but also in state-of-the-art structural engineering know how, a competitive selection process of the engineers

should be followed. In case such a competitive process cannot be justified from scope and size of the project, consultation with the municipality or concerned authority should be carried out before selecting engineer/architect.

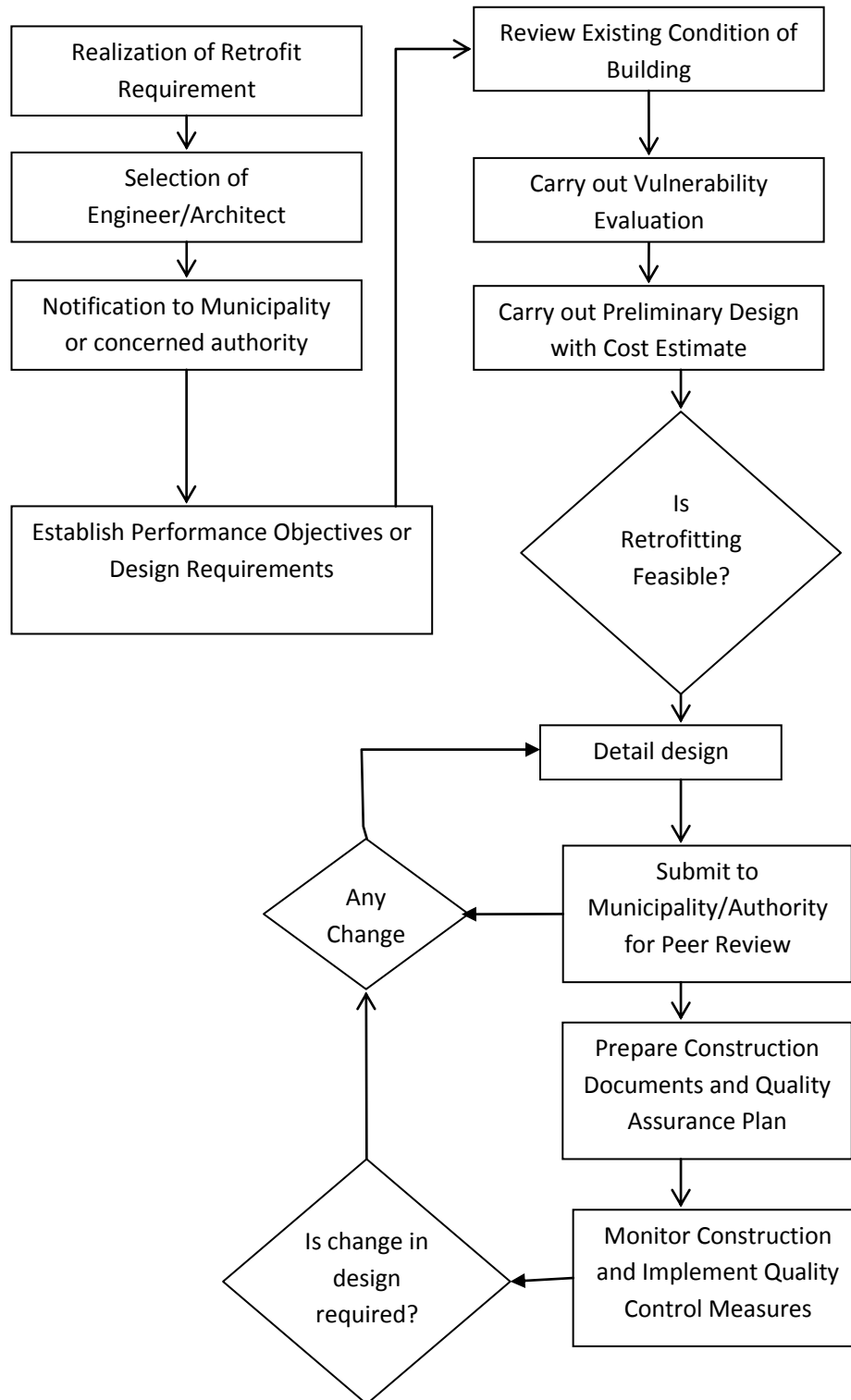

Figure 1-2 Step-by-step approach to evaluation, design and construction plan

## 1.7 NOTIFICATION TO MUNICIPALITY OR CONCERNED AUTHORITY

With the help of engineer, the owner shall give a preliminary notice to the municipality or the concerned authority stating purpose of the retrofitting and get go-ahead letter from the authorities. This is essential to record the intended purpose of the work and also to record the team of engineer(s) involved.

## 1.8 ESTABLISH PERFORMANCE OBJECTIVES OR DESIGN REQUIREMENTS

In consultation with the owner/client and as per requirement of the relevant NNBC or other relevant codes, the design team shall establish the seismic performance objectives and/or design requirements.

It should be noted that performance of a building may be different at different level of hazards and attaining a certain level of performance objectives consist of achieving a certain level of performance for a specific level of seismic hazard.

Similarly, the codal provisions for design requirements are different for different level of hazard. For example, IS code adopts following specification of hazard and expected level of damage<sup>4</sup>.

*The design approach adopted in this standard is to ensure that structures possess at least a minimum strength to withstand minor earthquakes (<DBE), which occur frequently, without damage; resist moderate earthquakes (DBE) without significant structural damage though some non-structural damage may occur; and aims that structures withstand a major earthquake (MCE) without collapse. Actual forces that appear on structures during earthquakes are much greater than the design forces specified in this standard. However, ductility, arising from inelastic material behavior and detailing, and overstrength, arising from the additional reserve strength in structures over and above the design strength, are relied upon to account for this different in actual and design lateral loads.*

---

<sup>4</sup> IS 1893: 2002 Criteria for Earthquake Resistant Design of Structures: Part 1 General Provisions and Buildings



## **1.9 REVIEW EXISTING CONDITION OF BUILDING**

Some of the preliminary information are essential before proceeding to the decision of retrofitting. Age of the building, design code (if any), existing condition of the building, change in use, buildings and physical facilities in the neighborhood of the building which can have impact on safety of the building, availability of drawings and other technical information such as geotechnical investigation report and intended future use of the building.

## **1.10 CARRY OUT VULNERABILITY EVALUATION**

The vulnerability evaluation of the building shall be carried out first as preliminary investigation and then, if required, detailed investigation. Preliminary investigation such as geometrical properties and existing condition of the building and detailed investigation can be carried out as suggested in the guideline developed by DUDBC under ERRRP project<sup>5</sup> or any other relevant guidelines.

## **1.11 CARRY OUT PRELIMINARY DESIGN WITH COST ESTIMATE**

At this stage it is advisable that engineers decide on feasibility of retrofitting for the building. Although detailed cost estimate requires detailed design, it is advisable to use engineering judgment on whether or not to proceed for retrofitting of the building. The decision, it is underscored, may depend on many other circumstances and economic viewpoint only may not be justified. For example, a historic building may require retrofitting even though the project may not be advised on economic analysis.

## **1.12 DETAIL DESIGN**

If the retrofitting is decided to carry out, detailed design is required before construction intervention. The detailed design shall be carried out according to the retrofitting guideline recommended for the particular building type.

## **1.13 PREPARE CONSTRUCTION DOCUMENTS AND QUALITY ASSURANCE PLAN**

The design engineer shall prepare construction drawings and documents according to the detailed design. A quality assurance plan to ensure enough quality control measures at sites

---

<sup>5</sup> Seismic Vulnerability Evaluation Guideline Part I-final, DUDBC, GON

shall also be prepared. These documents shall form the basis for selecting contractor for the purpose of retrofitting.

#### **1.14 SUBMISSION TO THE AUTHORITY**

The detailed design of retrofitting along with necessary documents stating the need to retrofit and works of vulnerability evaluation shall be submitted to the municipality or concerned authorities for approval. The authorities may submit, if required, the design details to peer review before giving approval.

#### **1.15 MONITORING AND QUALITY CONTROL**

It's the responsibility of the engineer to monitor the construction work and ensure quality assurance plan is being properly implemented. Any changes in the design dictated by the ground situation as the construction progresses shall be carried out by the engineer.

Such changes shall be brought to the notice of the authority and approval shall be received before proceeding the construction work.

## 2. ANALYTICAL PROCEDURE

An analysis of the building, including retrofitting measures, is conducted to determine the forces and deformations induced in components of the building by ground motion corresponding to the selected Earthquake Hazard Level, or by other seismic geologic site hazards.

The analysis procedure can be taken as linear and non-linear analysis. :

### 2.1 LINEAR PROCEDURES

Linear procedures are suitable for buildings which do not have an irregularity defined in earthquake resistant building design codes. For buildings that have one or more of the irregularities, linear procedures shall not be used unless the earthquake demands on the building comply with the demand capacity ratio (DCR) requirements.

The results of the linear procedures can be very inaccurate when applied to buildings with highly irregular structural systems, unless the building is capable of responding to the design earthquake(s) in a nearly elastic manner. The procedures of following section are intended to evaluate whether the building is capable of nearly elastic response.

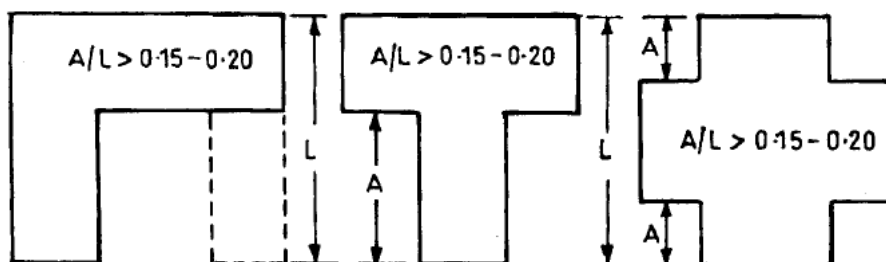

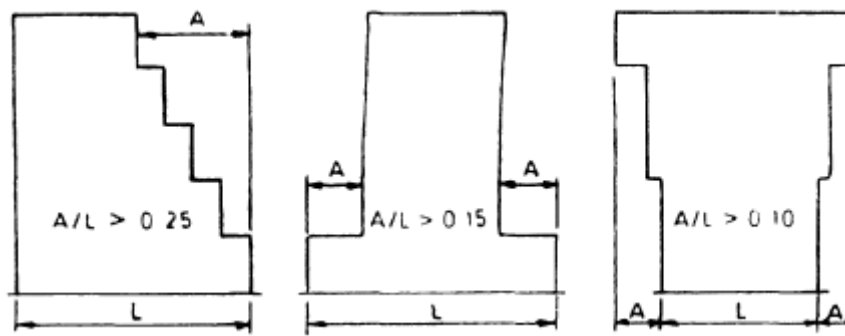

Figure 2-1 Irregularity in Plan and Elevation (IS 1893: 2002, details of other irregularities are given in Appendix 1)

## 2.2 NONLINEAR PROCEDURES

The Non-Linear procedures should be adopted whenever linear procedures are not suitable or when the designer has doubt about the behavior of the structure subject to linear analysis. The non-linear process can be Non-linear Static Process or Non-linear Dynamic Process. For this training purpose, the discussion is limited to Non-linear static procedure.

Non-linear Static Process can be used for structures in which higher mode effects are not significant. To determine if higher modes are significant, a modal response spectrum analysis shall be performed for the structure using sufficient modes to capture 90% mass participation. A second response spectrum analysis should also be performed, considering only the first mode participation. Higher mode effects is considered to be significant if the shear in any story resulting from the modal analysis considering modes required to obtain 90% mass participation exceeds 130% of the corresponding story shear considering only the first mode response.

The NSP is generally a more reliable approach to characterizing the performance of a structure than are linear procedures. However, it is not exact, and cannot accurately account for changes in dynamic response as the structure degrades in stiffness or account for higher mode effects. When the NSP is utilized on a structure that has significant higher mode response, the Linear Dynamic Process is also employed to verify the adequacy of the design but is excluded from the content of the training due to time limitation.

A systematic process to carry out non-linear static analysis is given in Appendix 2.

## 2.3 SEISMIC ASSESSMENT AND STRENGTH CHECK

### 2.3.1 RAPID ASSESSMENT (VISUAL SURVEY)

Rapid Seismic Assessment is the preliminary assessment , which concludes the recent status of the building as is it suitable to live in or not, can be retrofitted or not. In this process, the first level is site inspection, which is also called as visual survey.

#### **Methodology for Rapid Seismic Assessment:**

1. Review available Structural and Architectural Drawings
2. Review of the Design Data, if available.
3. Interview with the Designer, if possible.
4. Inspection of the Buildings.
5. Identification of Vulnerability Factors as per FEMA 310.
6. Determination of Strength of the Structural Components using Schmidt Hammer
7. Analysis of the Structural Systems, as per guidelines of FEMA 310.
8. Latest Photographs of the Building

#### **I. Building – facts:**

- Age of building
- Structural System – Load bearing Or Frame Structure
- Foundation Exploration
- Load path
- Geometry
- Walls Detail – Size and mortar
- Beam and Column Size
- Water proofing method
- Renovation of Building
- Other Structures added

## **II. Preliminary Evaluation**

A preliminary evaluation of building is carried out which involves broad assessment of its physical condition, robustness, structural integrity and strength of structure, including simple calculations. Approximate and quick checks shall be used to compute the strength and stiffness of building components. The seismic base shear and storey shears for the building shall be computed in accordance with IS1893 (Part1).

The preliminary evaluation is a quick procedure to establish actual structural layout and assess its characteristics that can affect its seismic vulnerability. It is a very approximate procedure based on conservative parameters to identify the potential earthquake risk of a building and can be used to screen buildings for detailed evaluation.

## **III. Site Visit**

A site visit will be conducted by the design professional to verify available existing building data or collect additional data, and to determine the condition of the building and its components.

## **IV. Acceptability Criteria**

A building is said to be acceptable if it meets all the configuration-related checks as well as global level checks on axial and shear stress as outlined in the following sections.

### **V. Configuration Related Checks**

#### **➤ Load Path:**

The structure shall contain at least one rational and complete load path for seismic forces from any horizontal direction so that they can transfer all inertial forces in the building to the foundation.

#### **➤ Redundancy:**

The number of lines of vertical lateral load resisting elements in each principal direction shall be greater than or equal to 2. In the case of moment/braced frames, the number of bays in each line shall be greater than or equal to 2.

#### **➤ Geometry:**

No change in the horizontal dimension of lateral force resisting system of more than 50% in a storey relative to adjacent stories, excluding penthouses and mezzanine floors, should be made.

➤ **Weak Storey:**

The strength of the vertical lateral force resisting system in any storey shall not be less than 70% of the strength in an adjacent storey.

➤ **Soft Storey:**

The stiffness of vertical lateral load resisting system in any storey shall not be less than 60% of the stiffness in an adjacent storey or less than 70% of the average stiffness of the three storeys above.

➤ **Vertical Discontinuities:**

All vertical elements in the lateral force resisting system shall be continuous from the root to the foundation.

➤ **Mass:**

There shall be no change in effective mass more than 100% from one storey to the next. Light roofs, penthouses, and mezzanine floors need not be considered.

➤ **Torsion:**

The estimated distance between a storey center of mass and the storey centre of stiffness shall be less than 30% of the building dimension at right angles to the direction of loading considered.

➤ **Adjacent Buildings:**

The clear horizontal distance between the building under consideration and any adjacent building shall be greater than 4% of the height of the shorter building, except for buildings that are of the same height with floors located at the same levels.

➤ **Short Columns:**

The reduced height of a column due to surrounding parapet, infill wall, etc. shall not be less than five times the dimension of the column in the direction of parapet, infill wall, etc. or 50% of the nominal height of the typical columns in that storey.

➤ **Strength-Related Checks**

Approximate and quick checks shall be used to compute the strength and stiffness of building components. The seismic base shear and storey shears for the building shall be computed in accordance with IS 1893 (Part1).

**a. Calculation of earthquake loads using Seismic coefficient method:**

The design horizontal seismic coefficient,  $A_h = Z \cdot I \cdot S_a / 2Rg$

Where,  $Z$  = Zone Factor

$I$  = Importance Factor

$R$  = Response Reduction  
Factor

$S_a/g$  = Average Response Acceleration Coefficient

The total design lateral force or Design Seismic Base Shear ( $V_B$ ) along any principal direction is determined by the following expression :

$$V_B = A_h * W$$

Where,  $A_h$  = The Design Horizontal Seismic Coefficient

$W$  = Seismic weight of the building

The approximate fundamental natural period of vibration ( $T_a$ ) in seconds, of all other buildings, including moment-resisting frame buildings with brick infill panels, may be estimated by the empirical expression:

$$T_a = 0.09h / d^{0.5}$$

Where,  $h$  = Height of Building in meter

$d$  = Base dimension of the building at the plinth level, in m,  
along the considered direction of the lateral force



## b. Distribution of base shear and calculation of shear stress in RC Columns

The design base shear (VB) computed in 1.5 shall be distributed along the height of the building as per the following expression:

$$Q_i = V_B \cdot (W_i h_i^2 / \sum W_i h_i^2)$$

Where,

$Q_i$  = Design lateral force at floor  $i$ ,

$W_i$  = Seismic weight of floor  $i$ ,

$h_i$  = Height of floor  $i$  measured from base

## c. Shear Stress in RC Frame Columns

Average Shearing stress in columns is given as

$$T_{col} = (n_c / (n_c - n_f)) * (V_j / A_c) < \min \text{ of } 0.4 \text{ Mpa and } 0.1 \text{ sq.rt.}(f_{ck})$$

$$0.1 \sqrt{f_{ck}} = 0.45$$

For Ground Storey columns,

$n_c$  = Total no. of Columns resisting lateral forces in the direction of loading

$n_f$  = Total no. of frames in the direction of loading

$A_c$  = Summation of the cross- section area of all columns in the storey under consideration

$V_j$  = Maximum Storey shear at storey level 'j'

DCR = Demand Capacity Ratio

#### **d. Axial Stress Check:**

#### **Axial stresses due to overturning forces as per FEMA 310**

##### **Axial stress in moment frames**

Axial force in columns of moment frames at base due to overturning forces,

The axial stress of columns subjected to overturning forces  $F_o$  is given by

$$F_o = 2/3 (V_b/n_f) \times (H / L)$$

$V_b$  = Base shear x Load Factor

$A_c$  = column area

H=total height

L=Length of the building

### **2.3.2 DETAILED EVALUATION**

A detailed evaluation is required unless results of preliminary evaluation are acceptable. The detailed evaluation procedure is based on determining the probable strength of lateral load resisting elements and comparing them with the expected seismic demands.

#### **2.3.2.1 Condition of the Building components:**

The building should be checked for the existence of some of the following common indicators of deficiency.

##### **(a) Deterioration of Concrete**

There should be no visible deterioration of the concrete or reinforcing steel in any of the vertical or lateral force resisting elements.

##### **(b) Cracks in Boundary Columns**

There shall be no existing diagonal cracks wider than 3 mm in concrete columns that encase masonry infills.

**(c) Masonry Units**

There shall be no visible deterioration of masonry units.

**(d) Masonry Joints**

The mortar shall not be easily scraped away from the joints by hand with a metal tool, and there shall be no areas of eroded mortar.

**(e) Cracks in Infill Walls**

There shall be no existing diagonal cracks in infill walls that extend throughout a panel, are greater than 3 mm, or have out-of-plane offsets in the bed joint greater than 3 mm.

**2.3.2.2 Condition of the Building Materials**

An evaluation of the present day strength of materials can be performed using on-site non-destructive testing and laboratory analysis of samples taken from the building. Field tests are usually indicative tests and therefore should be supplemented with proper laboratory facilities for accurate quantitative results.



Source: Photos by Hari. D. Shrestha Other than stated

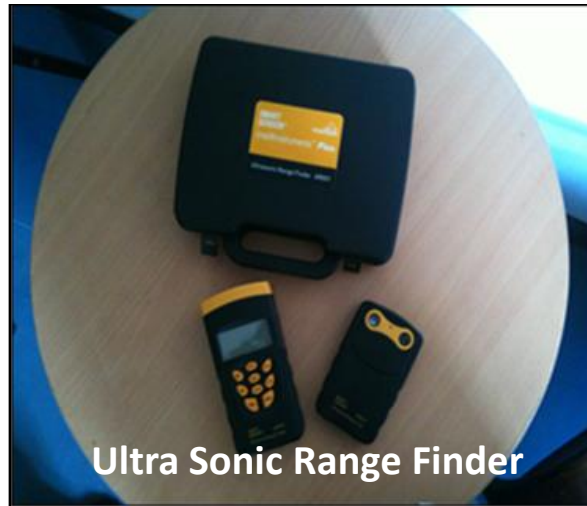

### 2.3.2.3 Evaluation Procedure

- *Calculation of Base Shear as defined in Preliminary Evaluation*
- *Shear capacity of frame members shall be adequate to develop the moment capacity at the ends, and shall be in accordance with provisions of IS: 13920 for shear design of beams and columns.*

The design shear force for columns shall be the maximum of:

- a) Calculated factored shear force as per analysis,
- b) a factored shear force given by,

$$V_u = 1.4 (M_1 + m_1') / hst$$

$M_1$  and  $m_1'$  are moment of resistance, of opposite signs, of beams framing into the column from opposite faces

- *All concrete columns shall be anchored into the foundation.*
- *The sum of the moment of resistance of the columns shall be at least 1.1 times the sum of the moment of resistance of the beams at each frame joint.*

$$\sum M_c \geq 1.1 \sum M_b$$

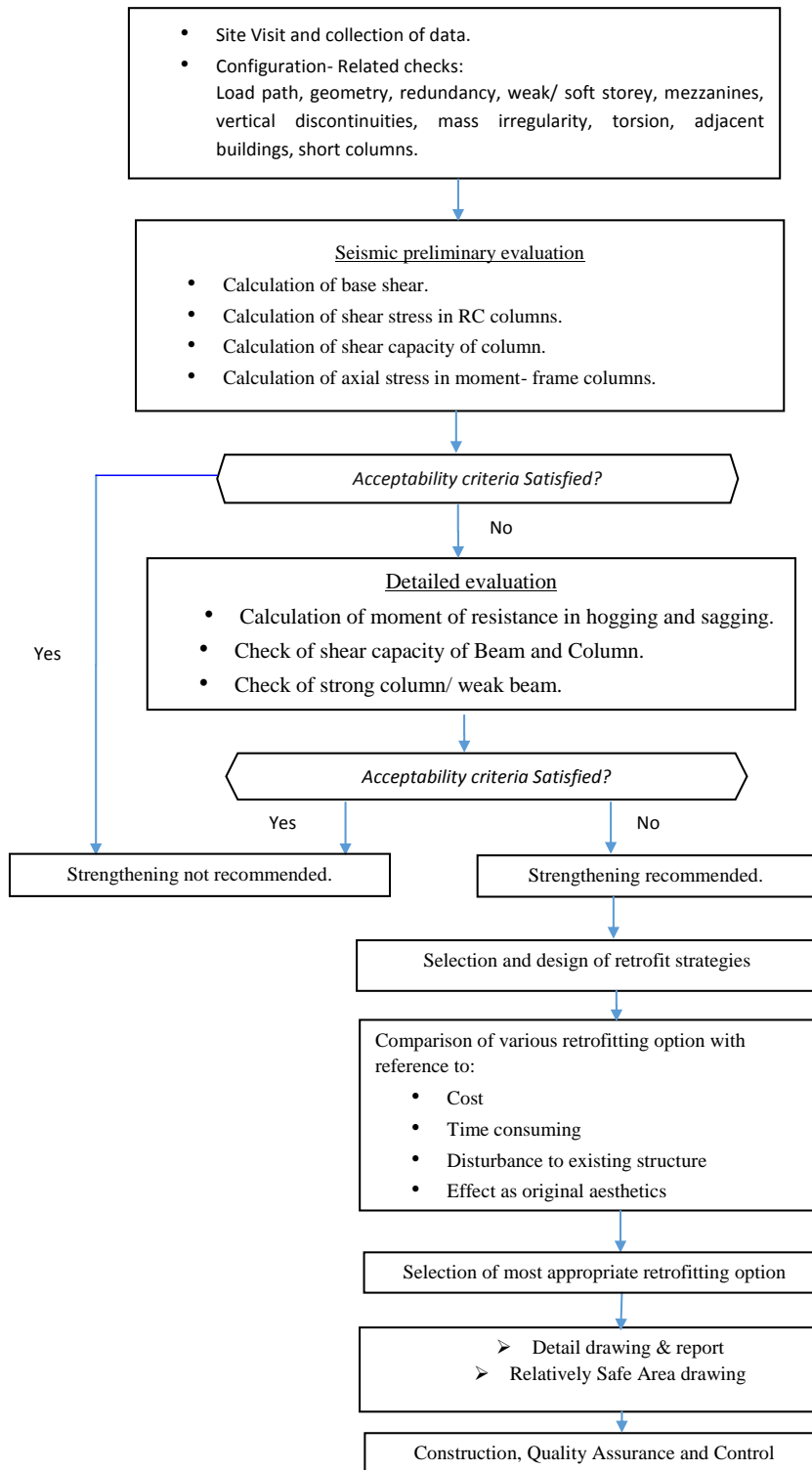

## 2.4 REQUIRED PERFORMANCE LEVEL

### 2.4.1 STRUCTURAL ELEMENTS

Limiting damage condition which may be considered satisfactory for a given building and given ground motion can be described as performance level.

The limiting condition is described by the physical damage within the building, the threat to life safety of the building's occupants created by the damage, and the post-earthquake serviceability of the building. The performance level ranges are assigned as:

- I. Immediate Occupancy (IO)
- II. Life Safety (LS)
- III. Collapse Prevention (CP)

#### **I. Immediate Occupancy (IO):**

The post-earthquake damage state in which only very limited structural damage has occurred. The basic vertical and lateral force resisting systems of the building retain nearly all of their pre-earthquake characteristic and capacities.

The risk of the life-threatening injury from structural failure is negligible, and the building should be safe for unlimited egress, ingress, and occupancy.

#### **II. Life Safety (LS):**

The post-earthquake damage state in which significant damage to the structure may have occurred but in which some margin against either total or partial structural collapse remains. Major structural components have not become dislodged and fallen, threatening life safety either within or outside the building. While injuries during the earthquake may occur, the risk of life threatening injury from structural damage is very low. It should be expected that extensive structural repairs will likely be necessary prior to reoccupation of the building.

#### **III. Collapse Prevention (CP):**

This level is the limiting post-earthquake structural damage state in which the building's structural system is on the verge of experiencing partial or total collapse. Substantial damage to the structure has occurred, potentially including significant degradation in the stiffness and strength of the lateral force resisting system. Although the building retain its overall stability,

significant risk of injury due to falling hazards may exist both within and outside the building and significant aftershock may lead to collapse. It should be expected that significant major structural repair will be necessary prior to re-occupancy.

## **2.4.2 NON STRUCTURAL ELEMENTS**

### **I. Immediate occupancy (IO)**

The post-earthquake damage state in which nonstructural elements and systems are generally in place and functional. Although minor disruption and cleanup should be expected, all equipment and machinery should be working. Contingency plans to deal with possible difficulties with external communication, transportation and availability of supplies should be in place.

### **II. Life safety (LS)**

The post-earthquake damage state could include minor disruption and considerable damage to nonstructural components and system particularly due to damage or shifting of contents. Although equipment and machinery are generally anchored or braced, their ability to function after strong shaking is not considered and some limitations on use or functionality may exist. Standard hazard from breaks in high pressure, toxic or fire suppression piping should not be present. While injuries during the earthquake may occur, the risk of life threatening injuries from nonstructural damage is very low.

### **III. Collapse prevention (CP)**

This post-earthquake damage state could include extensive damage to nonstructural components or systems but should not include collapse or falling of large and heavy items that could cause significant injuries to group of people, such as parapets, masonry exterior walls, cladding or large heavy ceilings. Nonstructural systems, equipments and machinery may not be functional without replacement or repair. While isolated serious injuries could occur, risk of failures that could put large numbers of people at risk within or outside the building is very low.



### 3. RETROFITTING TECHNIQUES

The choice of a retrofitting methodology depends on the type of building, required level of performance, availability of technology and overall, financial aspect. Some of the retrofitting techniques used for retrofitting RCC structures are given below:

- Jacketing – Increasing size of existing members
- Shear wall – providing additional shear walls in proper locations
- Bracing
- Dampers
- Base Isolation
- Addition of frames – Additional steel/concrete frames are added which contribute to the strength of the existing structure
- Others – There are many other methodologies, such as use of Fiber Reinforced Polymers (FRP), which can be effectively used for retrofitting of existing RCC structures.

These retrofitting procedures can be adopted in isolation or in combination of one or two methods.

Similarly for masonry and adobe structures, following are some of the common methods:

- Wall encasing by using
  - Wire meshing
  - Gabion wire
  - PP band
- Introduction of bands and stitches
- Strengthening/stiffening of roofs/floors
- Anchorage of roofs/floors with walls

- Strengthening of foundation
- Grouting

Additionally, it is always preferable to retrofit a structure at global level to reduce assymetricity and irregularity. For masonry structures, it's advisable to add cross walls if some of the walls are too long.

Some of the retrofitting techniques are illustrated below.

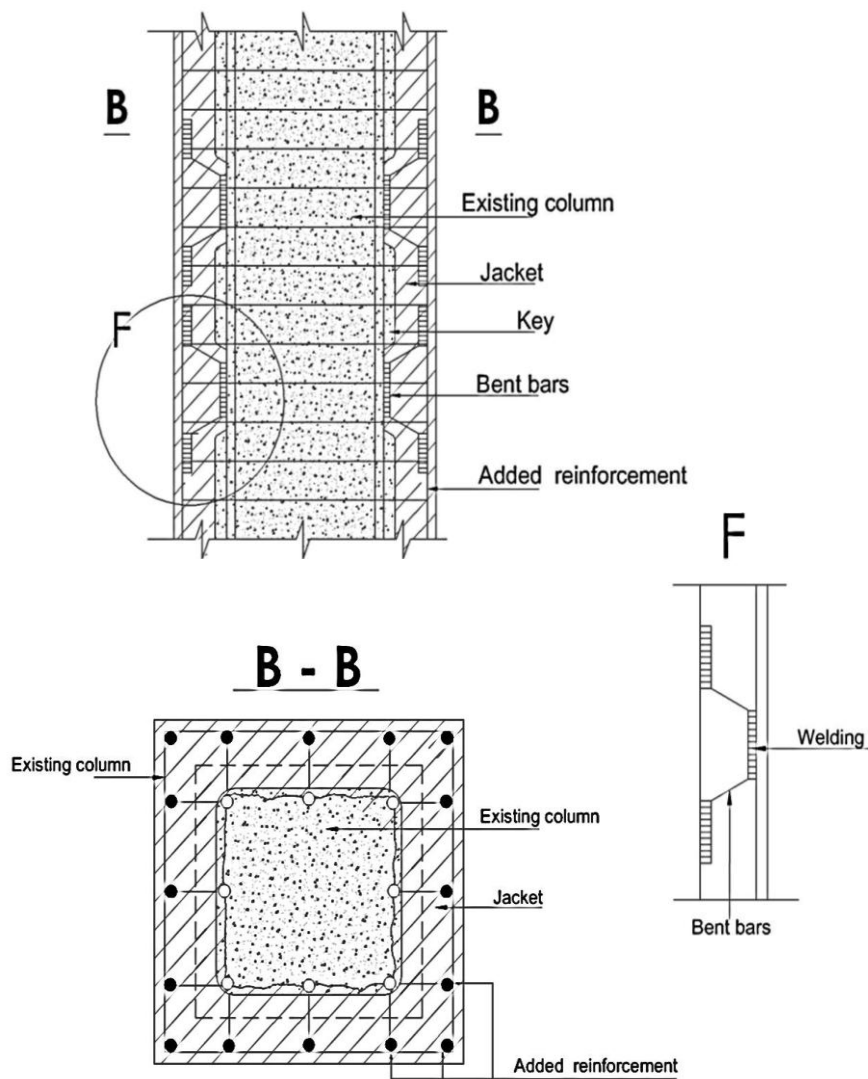

Figure 3-1 Jacketing a concrete column

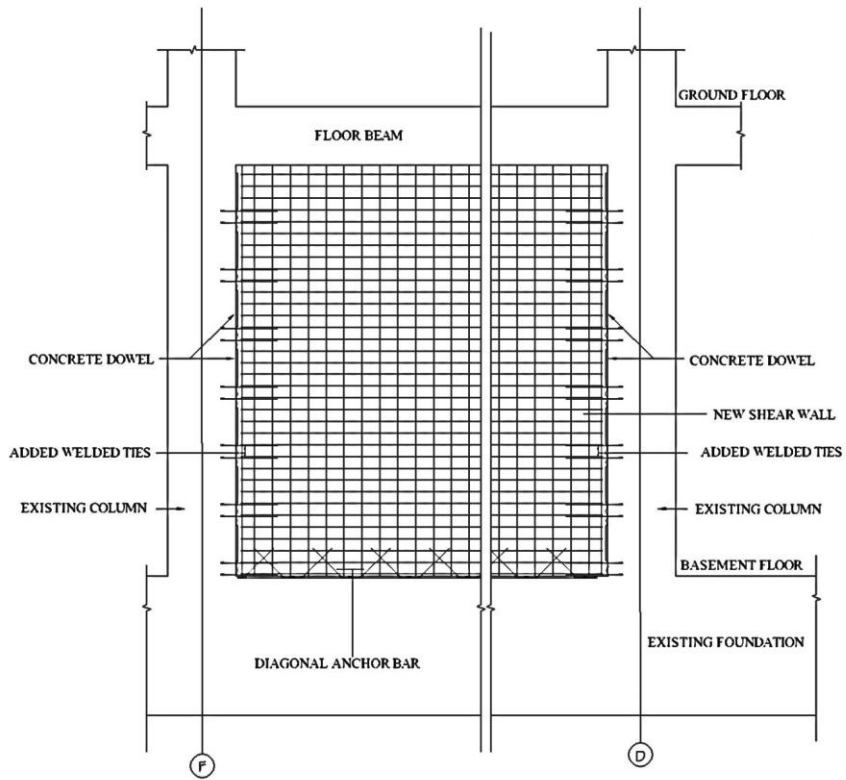

Figure 3-2 Introduction of a new shear wall



Figure 3-3 Introduction of a steel frame in existing RCC frame building



Figure 3-4 Introduction of dampers in existing RCC structure



Figure 3-5 Reinforcing masonry/ adobe walls with geo- mesh (source: World Housing Tutorial)

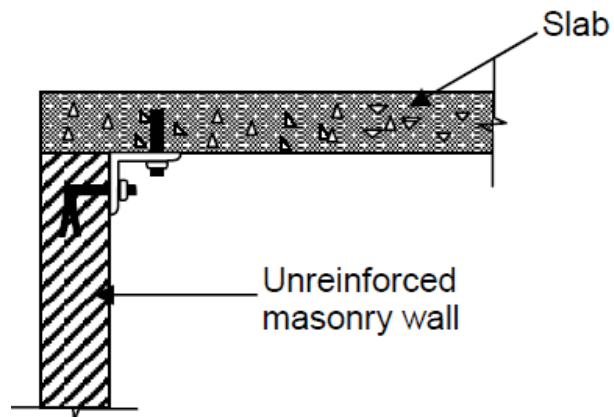

Figure 3-6 Anchorage of slab/ floor with masonry wall

#### 4. CONSTRUCTION TECHNOLOGY AND QUALITY CONTROL

Retrofitting is commonly used terminology for strengthening and/or rehabilitation of structures carried out to increase performance of the structure against different hazards. Retrofitting requires unique solution to each individual building and generalization, as in the new construction, has practical limitations. There are specific requirements in each and every step of retrofitting such as vulnerability assessment, design, planning, layout, construction sequence, quality control and safety assurance.

Construction is very important aspect of retrofitting as each building requires unique technique and duplicating similar approach may not always be the efficient way. An improper construction process not only damages the structure but also will be unsafe for the workers. An example of bad construction planning is shown in Figure 1 which shows that due to improper construction sequence an existing building (which was supposed to be retrofitted) was damaged completely and new building had to be constructed. Figure 4-1 (a) shows an existing structure which was supposed to be retrofitted. As the dismantling process started, the workers dismantled all supporting elements of the structure and whole structure became useless as see in Figure 4-1(c).

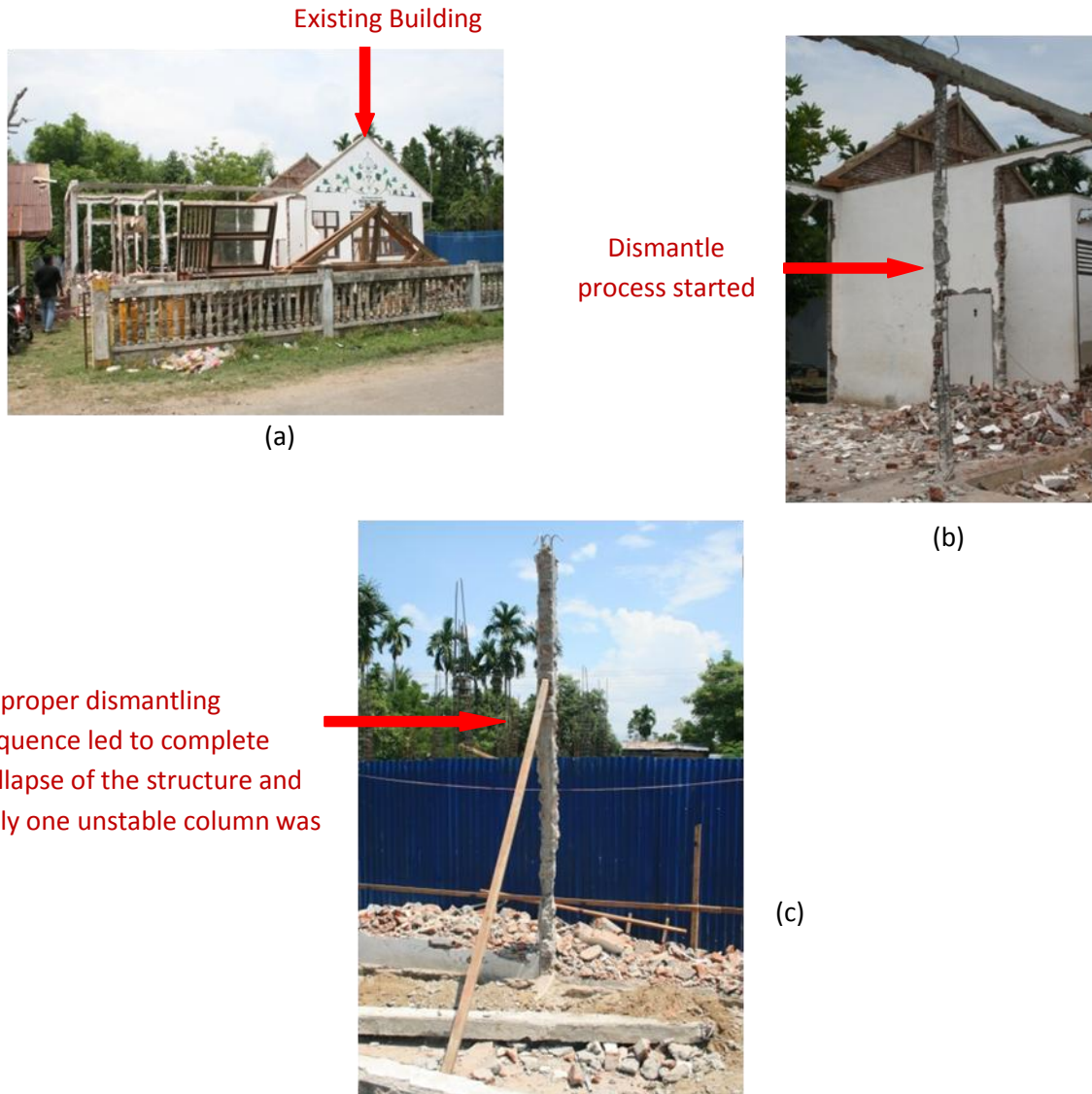

Figure 4-1 Improper construction sequence led to complete collapse of the structure during retrofitting

In order to establish a proper process for construction, the retrofitting design itself should provide detailed process of construction along with drawing as and when required.

Retrofitting approach to be carried out in the field is described in the following section for different elements

## 4.1 REPAIR OF FOUNDATION

The retrofitting of foundation, if required, shall be carried out in stages so that only a minimum of the structure is left unsupported in the foundation.

A schematic diagram of stage-wise retrofitting of foundation for load-bearing masonry structure is shown in Figure 3. Similar strategy shall be adopted for RCC framed structure as well.

A separate construction drawing showing the sequence of construction for foundation work shall be prepared, if necessary.

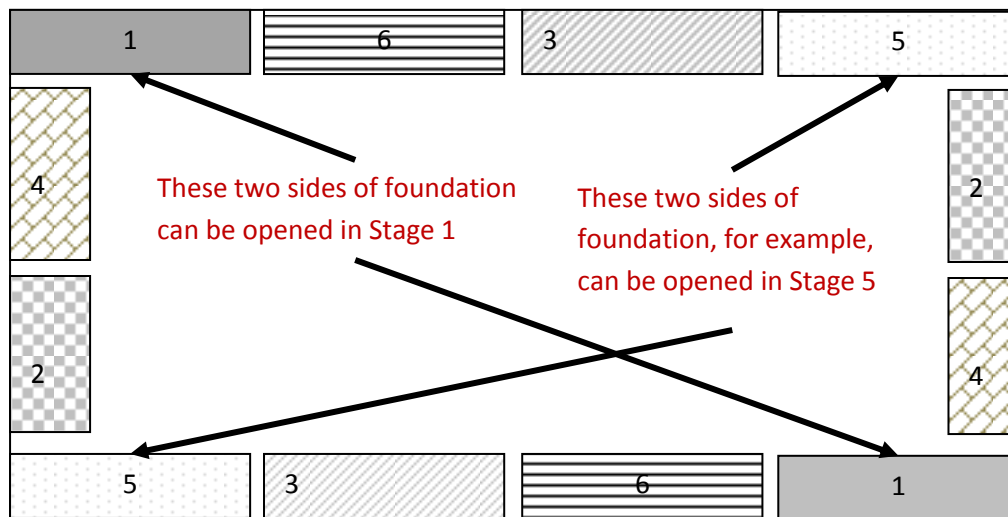

Figure 4-2 Schematic diagram showing stage wise retrofitting of foundation of load bearing masonry walls





In order to increase size of the footing and also to increase depth of footing, the foundation is opened. The process can be carried along with column jacketing, if

The concrete is laid in the opened foundation. Although reinforcement of the foundation is not shown here, reinforcement required from design is inserted. The reinforcement in the column is observed in the photo.



Completed foundation work for a corner column.

## 4.2 REPAIR OF COLUMN



The sides of a column are being opened for jacketing the corner column



The opening should be enough to accommodate reinforcement, additional concrete and workmanship.



Openings in the side of the wall to insert horizontal reinforcement in the walls which will provide support to the walls



Reinforcement placed in a corner column.

The reinforcement fabrication of conventional practice may not be suitable for example the complete circular rings ca not be inserted.



Similar is the case for formwork. A conventional formwork may not be suitable to cast concrete around an existing column and two halves as shown in the photographs may be required.

### 4.3 REPAIR OF BEAM



Beams need to properly connected with the columns and the reinforcement of column should continue toward the beam.

Opening of beam soffit needs special attention as the beam may deflect substantially due to gravity load.



Like in column, complete loop rings are not possible to insert in the beams. U-shaped rings with proper connection may be suitable and engineer should decide on type of bars and rings

## 4.4 REPAIR OF WALL



Gable walls are not recommended in earthquake prone areas. They should be removed and replaced with other materials such as CGI sheet. In case gable walls are unavoidable, Gable beam properly connected with the columns shall be placed.

The walls should be properly ties with the columns by providing reinforcement. In case infill walls are not tied, they should be protected by horizontal rings against out of plane failure.

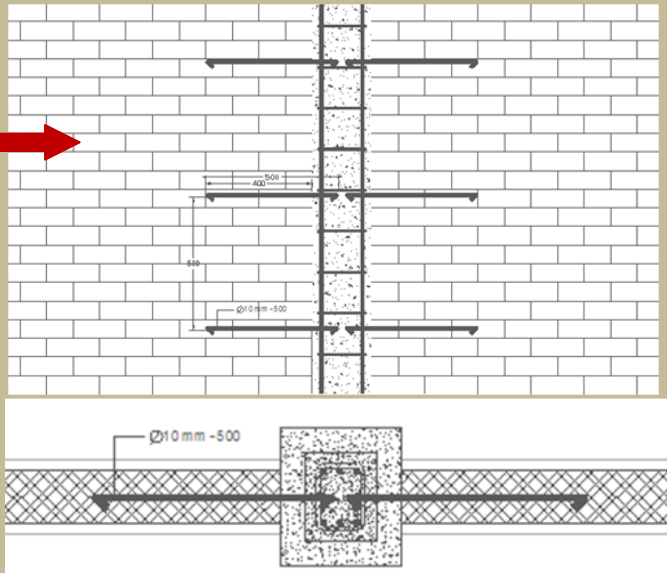

## 4.5 QUALITY CONTROL

Quality assurance program must be put in place to assure appropriate approach during evaluation, design and construction of all retrofit projects.

Vulnerability evaluation of each buildings require from preliminary visual assessment to detailed structural analysis. Depending on the scope of the project, size of the structure and location, a detailed geotechnical investigation may be required which should be decided by the engineer and the team.

Retrofit design shall be carried out only after detailed investigation of the existing structural system. The retrofit options depend on building features, scope and objective of the project and cost. The designer shall modify designs and drawings, if necessary, to reflect conditions encountered in the site as the construction progresses.

The designer “shall be responsible for performing periodic structural observation of the rehabilitation work. Structural observation shall be performed at significant stages of construction, and shall include visual observation of the work for substantial conformance with the construction documents and confirmation of conditions assumed during design. Structural observation shall be performed in addition to any special inspection and testing that is otherwise required for the work<sup>6</sup>.”

Retrofit design should be peer reviewed by a team of engineers independent from the project.

The designer shall, along with design drawings and specifications, also prepare quality assurance plan with provisions for special inspection and testing reports.

Construction planning and execution is the most critical part of any retrofit project. The importance of construction quality on building performance in general and the likelihood of encountering unforeseen conditions in retrofit construction in particular warrant special attention to construction monitoring and quality assurance<sup>7</sup>.

---

<sup>6</sup> FEMA 356

<sup>7</sup> ATC-40



Quality control in field is very important to achieve the required performance of a building. Simple and easily available measures such as slump test are very effective in the field.



Continuous monitoring and supervision is required. Quality check of finished product is recommended.

**Example****Seismic Evaluation of Residential RCC Building which Converted to Health Clinic (Occupancy Change)**

This building is RCC frame structure situated at Khusibu, Naya Bazar. This building is in good condition and well maintained but built before seismic code was introduced in Nepal.

The size of column is 230mm x 230mm, beam size of 230mm x 350mm, slab thickness of 125mm and storey height of 2.7m. It consists of 3- storey. The column size 230mm x 230mm is not sufficient referring to the latest Nepal Code which shows deficit at the site inspection itself.

The building was built for the purpose of residential use. After the fast urbanization this locality of the building, Khusibu, is more commercial so now this building to be converted into the health clinic.

**1. General Description of Existing Building**

Table 5-1 General Description of Existing Building

<b>Building Description : RCC Frame Structural</b> ( In good Condition, but built before Seismic Code introduced in NEPAL )	Site Visit/ Visual Inspection/Site measurements
Location : Khusibhu, Naya Bazar	Site Visit/ Visual Inspection/Site measurements
Storey height : 2.7 m	Site Visit/ Visual Inspection/Site measurements
No. of Stories : 3 nos	Site Visit/ Visual Inspection/Site measurements
Column Size : 230mm *230 mm	Site Visit/ Visual Inspection/Site measurements
Beam Size : 230 mm *350 mm	Site Visit/ Visual Inspection/Site measurements
Slab thickness : 125 mm	Site Visit/ Visual Inspection/Site measurements



Type of foundation : Isolated foundation	Site Visit/ Foundation Exploration
--	------------------------------------

## 2. Structural Assessment Checklist:

Table 5-2 Structural Assessment Checklist

S.N.	CHECKS	REMARKS
1.	Load Path	<i>The frame system provides a complete load path which transfers all inertial forces in the building to the foundation.</i>
2.	Redundancy	<i>There are two bays of frame in each direction.</i>
3.	Geometry	<i>The plan of the building is same in all stories.</i>
4.	Weak Storey / Soft Storey	<i>There is no weak / soft storey.</i>
5.	Vertical Discontinuities	<i>Vertical elements in the lateral force resisting system are continuous to the foundation.</i>
6.	Mass	<i>There is no change in effective mass in adjacent floors except at top floor.</i>
7.	Torsion	<i>The eccentricity of the building is not within the limit.</i>
8.	Adjacent Buildings	<i>There are no adjacent buildings.</i>
9.	Short Column	<i>No short column effect</i>
10.	Deterioration of Concrete	<i>No visible deterioration observed. No cracks were observed.</i>

### 3. Building Drawings:

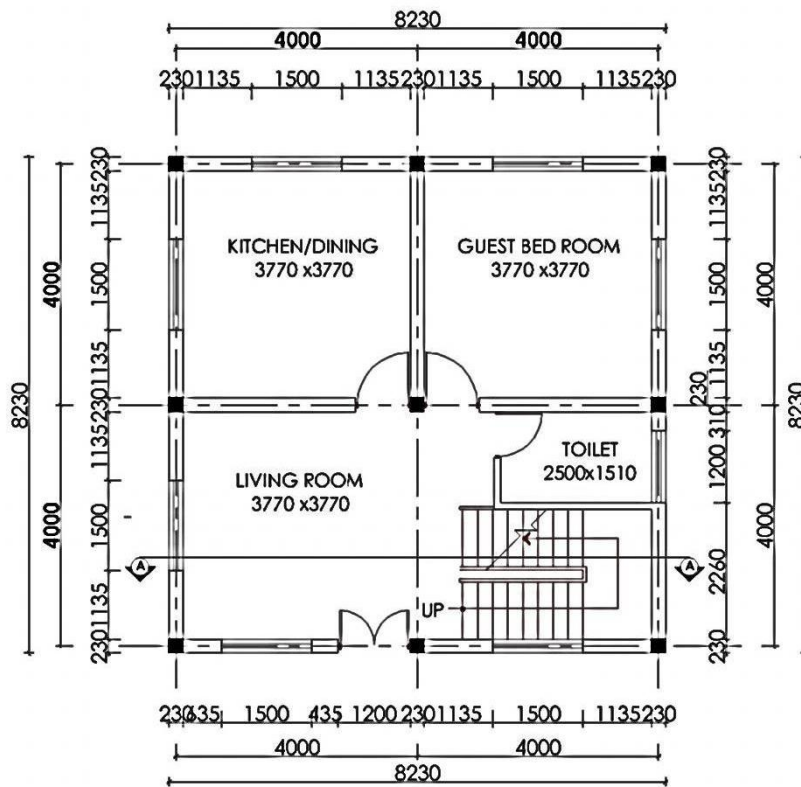

**GROUND FLOOR PLAN**  
**AREA= 67.73 sq. mt**

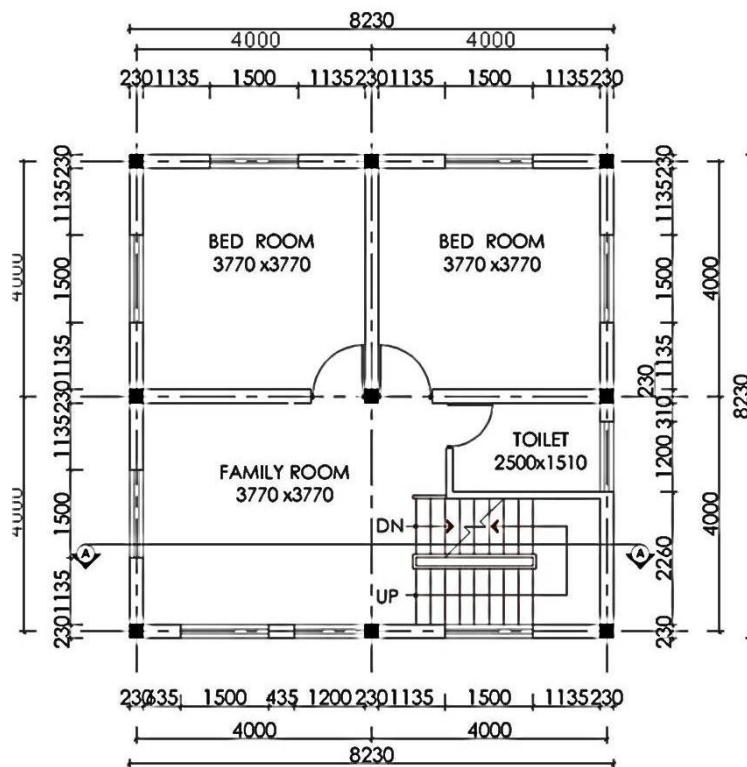

**FIRST FLOOR PLAN**  
**AREA= 67.73 sq. mt**

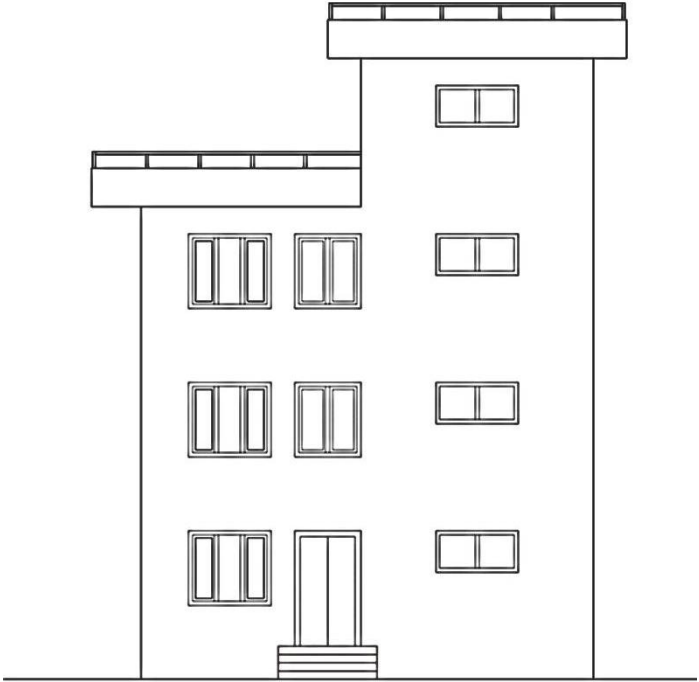

**FRONT ELEVATION**

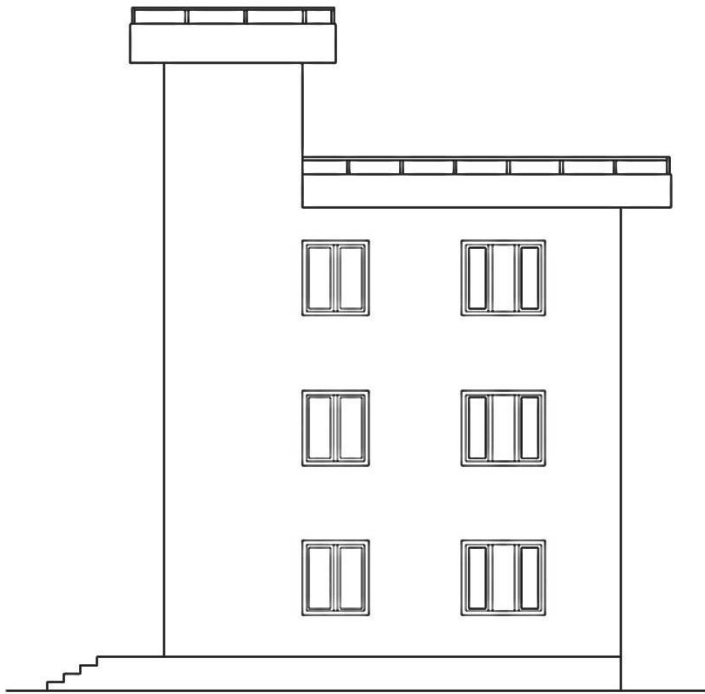

**SIDE ELEVATION**

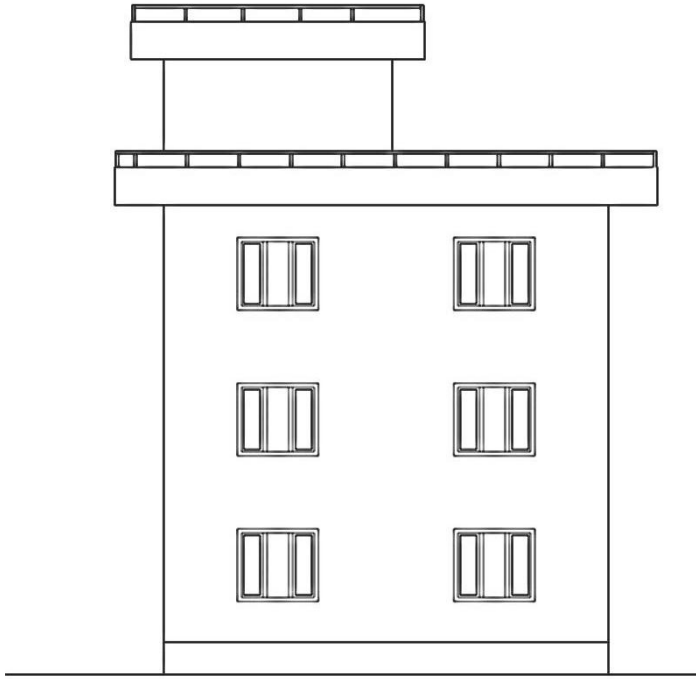

**BACK ELEVATION**

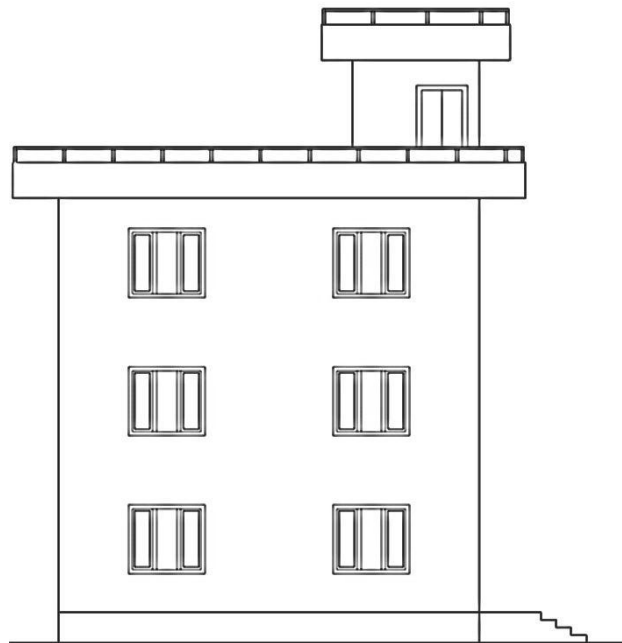

**SIDE ELEVATION**

#### 4. Structural Data :

Unit Weight of RCC = 25 KN/m<sup>3</sup>

Unit Weight of Brick Masonry : 19.6 KN/m<sup>3</sup>

Unit Weight of Plaster : 20 KN/m<sup>3</sup>

Unit Weight of Marble : 26.7 KN/m<sup>3</sup>

#### Live load:

For Floors = 2.5 KN/m<sup>2</sup> (Residential building)

For Roof = 1.5 KN/m<sup>2</sup>

Grade of Concrete = M20                      Site Visit/ Visual Inspection/Site Measurements

Grade of Steel = Fe 415                      Site Visit/ Visual Inspection/Site Measurements

*(Stiffness of the Brick Masonry is not considered in the calculation)*

#### 5. LOAD CALCULATIONS

##### Dead Load:

##### I. For Different Floors:

Slab Load :                       $0.125 * 25 = 3.125 \text{ KN/m}^2$

Ceiling Plaster Load :                       $0.02 * 20 = 0.40 \text{ KN/m}^2$

Floor Finish Load :                       $0.025 * 20 = 0.50 \text{ KN/m}^2$

Marble Floor Load :                       $0.025 * 26.7 = 0.667 \text{ KN/m}^2$

Total Load =                       $4.692 \text{ KN/m}^2$

~ 4.70 KN/m<sup>2</sup>

##### II. For Roof Floor:

Slab Load :                       $0.125 * 25 = 3.125 \text{ KN/ m}^2$

Ceiling Plaster Load :  $0.02 * 20 = 0.40 \text{ KN/ m}^2$

Floor Finish Load :  $0.025 * 20 = 0.50 \text{ KN/ m}^2$

Mosaic Floor Load :  $0.025 * 20 = 0.50 \text{ KN/ m}^2$

Total Load :  $4.525 \text{ KN/m}^2$

$\sim 4.50 \text{ KN/m}^2$

## 6. Strength Related Checks

### ANALYSIS AS RESIDENTIAL BUILDING :

The following is a detail of quick check calculations based on FEMA 310 for the seismic evaluation of building under consideration:-

Assumptions:

Unit weight of brick work =  $19.6 \text{ kN/m}^3$

Live load =  $2.5 \text{ kN/m}^2$

#### a. LIVE LOAD CALCULATION

LEVEL	FLOORS	FLOOR AREA (sq.m)	LL (kN/m <sup>2</sup> )	0.25LL	Remarks
4	Third Floor	29.485	44.2275	11.057	
3	Second Floor	90.33	225.825	56.456	
2	First Floor	67.73	169.325	42.331	
1	Ground Floor	67.73	169.325	42.331	
$\Sigma$				<b>152.18</b>	

**b. LUMP MASS CALCULATION**

S.NO.	FLOORS	Total Dead	Total Live	Total Weight	Remarks
		Load (KN)	Load (KN)	( KN )	
4	Third Floor	260.48	11.056875	271.54	
3	Second Floor	756.04	56.45625	812.50	
2	FirstFloor	649.82	42.33125	692.15	
1	Ground Floor	649.82	42.33125	692.15	
$\Sigma$				<b>2468.34</b>	

**c. CALCULATION OF BASE SHEAR**

Calculation of base shear can be done using following codes:

- a) IS1893:2002(Part 1)
- b) NBC 105:1994

**Based on IS 1893 (Part 1): 2002,**

Calculation of earthquake loads using Seismic coefficient method:

The design horizontal seismic coefficient,  $A_h = Z \cdot I \cdot S_a / 2Rg$

Where  $Z =$  Zone Factor

$I =$  Importance Factor

$R =$  Response Reduction Factor

$S_a/g =$  Average Response Acceleration Coefficient

The total design lateral force or Design Seismic Base Shear ( $V_B$ ) along any principal direction is determined by the following expression :

$$V_B = A_h * W$$

Where,  $A_h$  = The Design Horizontal Seismic Coefficient

$W$  = Seismic weight of the building

The approximate fundamental natural period of vibration ( $T_a$ ) in seconds, of all other buildings, including moment-resisting frame buildings with brick infill panels, may be estimated by the empirical expression:

$$T_a = 0.09h / d^{0.5}$$

$h$  = Height of Building in meter

Where,  $d$  = 10.80 m

$d$  = Base dimension of the building at the plinth level, in m, along the considered direction of the lateral force

$$d_x = 8.23 \text{ m}$$

$$d_z = 8.23 \text{ m}$$

$$T_{ax} = 0.09h / d_x^{0.5}$$

$$= 0.338 < 0.55$$

$$T_{az} = 0.09h / d_z^{0.5}$$

$$= 0.338 < 0.55$$

Therefore,  $S_a/g = 2.5$  for medium soil (IS :1893(Part 1) : 2002

$Z = 0.36$  (For Seismic Zone V) (Refer IS 1893 (Part 1) :2002-table 2 )

$I = 1.0$  ( For Residential Building ) (Refer IS 1893 (Part 1) :2002-table 6 )

$S_a/g = 2.5$  (For Medium Soil ) (Refer IS 1893 (Part 1) :2002-Clause 6.4.5 and Fig.2 )

$R = 3.0$  (For Ordinary RC Moment Resisting Frame ) (Refer IS 1893 (Part 1) :2002-table 7 )



The total design lateral force or design seismic base shear is given by,

$$A_h = ZISa/2Rg$$

$$= 0.36 * 1.0 * 2.5 / 2 * 3$$

$$= 0.15$$

$$\text{Base shear} = V_b = A_h * W$$

$$= 0.15 * 2468.34$$

$$= 370.251 \text{ kN}$$

**d. Distribution of Base Shear and Calculation of Shear Stress in RC Columns :**

Floor	Total weight	Height $h_i$ (m)	$W_i * h_i^2$	$W_i * h_i^2 / \sum W_i h_i^2$	$Q_i$ (KN)	Storey Shear $V_i$ (KN)
	$W_i$ (KN)					
4.00	271.54	10.8	31672.06	0.29	106.40	106.40
3.00	812.50	8.1	53307.88	0.48	179.09	285.49
2.00	692.15	5.4	20183.13	0.18	67.81	353.30
1.00	692.15	2.7	5045.78	0.05	16.95	370.25
$\Sigma$	<b>2468.34</b>		<b>110208.85</b>	<b>1.00</b>	<b>370.25</b>	

**e. SHEAR STRESS AT STOREY LEVEL :**

(Using IITK-GSDMA Guidelines for Seismic Evaluation and Strengthening of buildings 6.5.1)

The Total design lateral force or design seismic base shear is given by,

$$V_b = A_h \times W$$

Average Shearing stress in columns is given as

$$T_{col} = (n_c / (n_c - n_f)) * (V_j / A_c) < \min \text{ of } 0.4 \text{ Mpa and } 0.1 \text{ sq.rt.}(f_{ck})$$

For Ground Storey columns,

$n_c$  = Total No. of Columns resisting lateral forces in the direction of loading

$n_f$  = Total No. of frames in the direction of loading

$A_c$  = Summation of the cross- section area of all columns and shear wall in the storey under consideration

$V_j$  = Maximum Storey Shear at storey level 'j'

### Shear Stress at Storey Levels

Storey	nc	nf1	nf2	Ac	Storey Shears (KN)	Shear Stress	
						T col 1(MPa)	T col 2(MPa)
4	4	2	2	0.211	106.40	1.01	1.01
3	9	3	3	0.476	285.49	0.90	0.90
2	9	3	3	0.476	353.30	1.11	1.11
1	9	3	3	0.476	370.25	1.17	1.17

$$T_{col} \gg \min \text{ of } 0.4 \text{ MPa and } 0.1 \text{ sqrt}(f_{ck}) = 0.45 \text{ MPa}$$

***Hence, the check is not satisfied.***

## ANALYSIS AS HEALTH CLINIC:

Major changes while converting Residential building into Health clinic

S.No	Description of Building	Live load(kN/m <sup>2</sup> )	Importance Factor
1.	Residential	2.5	1
2.	Health Clinic	3	1.5

The following is a detail of quick check calculations based on FEMA 310 for the seismic evaluation of building under consideration.

Assumptions:

Unit weight of brick work = 19.6 kN/m<sup>3</sup>

Live load = 3.0 kN/m<sup>2</sup>

### a. LIVE LOAD CALCULATION

LEVEL	FLOORS	FLOOR AREA	LL	0.25LL	Remarks
		sq.m			
4	Third Floor	29.485	44.2275	11.056875	
3	Second Floor	90.33	270.99	67.7475	
2	First Floor	67.73	203.19	50.7975	
1	Ground Floor	67.73	203.19	50.7975	
Σ				<b>180.39938</b>	

### b. LUMP MASS CALCULATION

S.NO.	FLOORS	Total Dead	Total Live	Total Weight	Remarks
		Load (KN)	Load (KN)	( KN )	
4	Third Floor	260.48	11.056875	271.54	
3	Second Floor	756.04	67.7475	823.79	
2	First Floor	649.82	50.7975	700.62	
1	Ground Floor	649.82	50.7975	700.62	
$\Sigma$				<b>2496.56</b>	

### c. CALCULATION OF BASE SHEAR

The total design lateral force or design seismic base shear is given by

Based on IS 1893 (Part 1): 2002, Criteria for earthquake resistant design of structures,

Calculation of earthquake loads using Seismic coefficient method:

The design horizontal seismic coefficient,  $A_h = Z \cdot I \cdot S_a / 2Rg$

Where  $Z =$  Zone Factor

$I =$  Importance Factor

$R =$  Response Reduction Factor

$S_a/g =$  Average Response Acceleration Coefficient

The total design lateral force or Design Seismic Base Shear ( $V_B$ ) along any principal direction is determined by the following expression :

$$V_B = A_h * W$$

Where,

$A_h$  = The Design Horizontal Seismic Coefficient

$W$  = Seismic weight of the  
building

The approximate fundamental natural period of vibration ( $T_a$ ) in seconds, of all other buildings, including moment-resisting frame buildings with brick infill panels, may be estimated by the empirical expression:

$$T_a = 0.09h / d^{0.5}$$

Where,  $h$  = Height of Building in meter = 10.80 m

$d$  = Base dimension of the building at the plinth level, in m, along the considered direction of the lateral force

$$d_x = 8.23 \text{ m}$$

$$d_z = 8.23 \text{ m}$$

$$T_{ax} = 0.09h / d_x^{0.5}$$

$$= 0.338 < 0.55$$

$$T_{az} = 0.09h / d_z^{0.5}$$

$$= 0.338 < 0.55$$

Therefore,  $S_a/g = 2.5$  for medium soil (IS :1893(Part 1) : 2002

$Z = 0.36$  (For Seismic Zone V )

(Refer IS 1893 (Part 1) :2002-table 2 )

$I = 1.50$  ( For Clinic Building )

(Refer IS 1893 (Part 1) :2002-table 6 )

Sa/g = 2.5 (For Medium Soil )  
 Fig.2 )

(Refer IS 1893 (Part 1) :2002-Clause 6.4.5 and

R = 3.0 (For Ordinary RC Moment Resisting Frame ) (Refer IS 1893 (Part 1) :2002-table 7 )

$$A_h = ZISa/2Rg$$

$$= 0.36 * 1.5 * 2.5 / 2 * 3$$

$$= 0.225$$

$$\text{Base shear} = V_b = A_h * W$$

$$= 0.225 * 2496.56$$

$$= 561.726 \text{ KN}$$

**d. Distribution of Base Shear and Calculation of Shear Stress in RC Columns :**

Floor	Total weight	Height hi (m)	Wi*hi <sup>2</sup>	Wi*hi <sup>2</sup> /∑Wihi <sup>2</sup>	Qi(KN)	Storey Shear Vi (KN)
	Wi (KN)					
4.00	271.54	10.8	31672.06	0.28	159.91	159.91
3.00	823.79	8.1	54048.70	0.49	272.88	432.79
2.00	700.62	5.4	20430.01	0.18	103.15	535.94
1.00	700.62	2.7	5107.50	0.05	25.79	561.73
∑	<b>2496.56</b>		<b>111258.27</b>	<b>1.00</b>	<b>561.73</b>	

**e. SHEAR STRESS AT STOREY LEVEL :**

(Using IITK-GSDMA Guidelines for Seismic Evaluation and Strengthening of buildings 6.5.1)

The Total design lateral force or design seismic base shear is given by

$$V_b = A_h \times W$$

Average Shearing stress in columns is given as

$$T_{col} = (n_c / (n_c - n_f)) * (V_j / A_c) < \text{min of } 0.4 \text{ Mpa and } 0.1 \text{ sq.rt.}(f_{ck})$$

For Ground Storey columns,

$n_c$  = Total No. of Columns resisting lateral forces in the direction of loading

$n_f$  = Total No. of frames in the direction of loading

$A_c$  = Summation of the cross- section area of all columns and shear wall in the storey under consideration

$V_j$  = Maximum Storey Shear at storey level 'j'

**Shear Stress at Storey Levels**

Storey	$n_c$	$n_{f1}$	$n_{f2}$	$A_c$	Storey Shears (KN)	Shear Stress	
						T col 1(MPa)	T col 2(MPa)
4	4	2	2	0.211	159.91	1.52	1.52
3	9	3	3	0.476	432.79	1.36	1.36
2	9	3	3	0.476	535.94	1.69	1.69
1	9	3	3	0.476	561.73	1.77	1.77

$$T_{col} \gg \min \text{ of } 0.4 \text{ MPa} \quad \text{and } 0.1\sqrt{f_{ck}} = \quad 0.45 \text{ MPa}$$

***Hence, the check is not satisfied.***

Since columns are not safe, now checking for different categories as below:

**f. Calculation of Shear Capacity of Colum Using Capacity design Method :**

**• Checking Shear Capacity of Center Column :**

Shear Capacity of column required =  $1.4 ( M_1 + m_1 ) / h_{st}$

The longitudinal Beam size is equal to  $230 * 350$ .

Reinforcement of Beam is equal to 3 TOR 16 top and bottom.

Where,

$$b = 230$$

$$D = 350$$

$$d = 350 - 25 - 16/2$$

$$= 317$$

The Moment Capacities are evaluated from STAADPro 2006,

which is equal to 68.6 KN-m and 53.6 KN-m.

Shear force in Column corresponding to these moments :

$$V_u = 1.4 ( M_1 + m_1 ) / h_{st}$$

$$= 1.4 * ( 68.6 + 53.6 ) / 2.7$$

$$= 63.36 \quad \text{KN}$$



Size of Column = 230 mm \* 230 mm

Area of Steel ( $A_{st}$ ) = 4 tor 12 diameter

$F_{ck} = 20 \text{ N/mm}^2$

$F_y = 415 \text{ N/mm}^2$

From SP 16 Table 61

for  $P_t = 0.85\%$  ,  $\tau = 0.585 \text{ N/mm}^2$

Shear Capacity =  $0.585 * 230 * 230 / 1000$

$$= 30.94 \text{ kN}$$

Shear to be carried Stirrups  $V_{us} = 63.36 - 30.94$

$$= 32.42 \text{ KN}$$

From SP 16 Table 62 :

Stirrups in the Column : Tor 8 Diameter @ 150 mm c/c

$$V_{us} / d = 2.42 \text{ kN/ cm}$$

$$V_{us} = 2.42 * 19.2 \text{ kN/ cm}$$

$$= 46.5 \text{ kN} \gg 32.42 \text{ KN}$$

***Hence, the Check for shear tie is satisfied for central column.***

**g. Axial Stress Check:**

***The Axial Stress due to Gravity Loads as per FEMA 310***

Permissible axial stress =  $0.1f_c' = 2 \text{ N/mm}^2$

The axial stress due to gravity loads in the center column of Ground Floor = 711.289 kN

The axial stress due to gravity loads in column

$$\begin{aligned} &= \text{Load on column(N)} / \text{Cross section Area of Column} = 711.289 \times 1000 / 230 / 230 \\ &= 13.446 \text{ N/mm}^2 > 2 \text{ N/mm}^2 \end{aligned}$$

***Hence the check not satisfied.***

***h. Axial stresses due to overturning forces as per FEMA 310***

**Axial stress in moment frames for x-direction loading**

Axial force in columns of moment frames at base due to overturning forces,

The axial stress of columns subjected to overturning forces  $F_o$  is given by

$$F_o = 2/3 (V_b/n_f) \times (H / L)$$

$V_b = \text{Base shear} \times \text{Load Factor}$

$$561.726 \times 1.5 = 842.59 \text{ kN}$$

$$A_c = \text{column area} = 0.0529 \text{ sq.m.}$$

$$H = \text{total height} = 10.8 \text{ m}$$

$$L = \text{Length of the building} = 8.00 \text{ m}$$

$$F_o = 2/3 (V_b/n_f) \times (H / L)$$

$$= 252.78 \text{ kN}$$

Axial Stress for x-direction loading,

$$\sigma = \frac{252.78}{0.05} = 4.78 \text{ MPa}$$

$$\sigma_{\text{all}} = 0.25 f_{\text{ck}} = 5.00 \text{ MPa}$$

therefore  $\sigma < \sigma_{\text{all}}$  OK

**DCR = 0.334**

*Hence the check is satisfied*

**Axial stress in moment frames for z-direction loading**

Axial force in columns of moment frames at base due to overturning forces,

The axial stress of columns subjected to overturning forces  $F_o$  is given by

$$F_o = 2/3 (V_b/n_f) \times (H / L)$$

$V_b$  = Base shear x Load Factor

$$561.726 \times 1.5 = 842.59 \text{ kN}$$

$$A_c = \text{column area} = 0.0529 \text{ sq.m.}$$

$$H = \text{total height} = 10.8 \text{ m}$$

$$L = \text{Length of the building} = 8.00 \text{ m}$$

$$F_o = 2/3 (V_b/n_f) \times (H / L)$$

$$= 252.78 \text{ kN}$$

Axial Stress for x-direction loading,

$$\sigma = \frac{252.78}{0.05} = 4.78 \text{ MPa}$$

$$\sigma_{\text{all}} = 0.25 f_{\text{ck}} = 5.00 \text{ MPa}$$

therefore  $\sigma < \sigma_{\text{all}}$  OK

**DCR = 0.334**

*Hence the check is satisfied*

**i. Check for Out-of-Plane Stability of Brick Masonry Walls**

Wall Type	Wall Thickness	Recommended Height/Thickness ratio ( $0.24 < S_x \leq 0.35$ )	Actual Height/Thickness ratio in building	Comments
Wall in ground storey	230mm	18	$(2700-350)/230 = 10.217$	Pass
Wall in upper stories	230mm	16	$(2700-350)/230 = 10.217$	Pass

*Hence the check is satisfied*

**RETROFITTING DRAWINGS:**

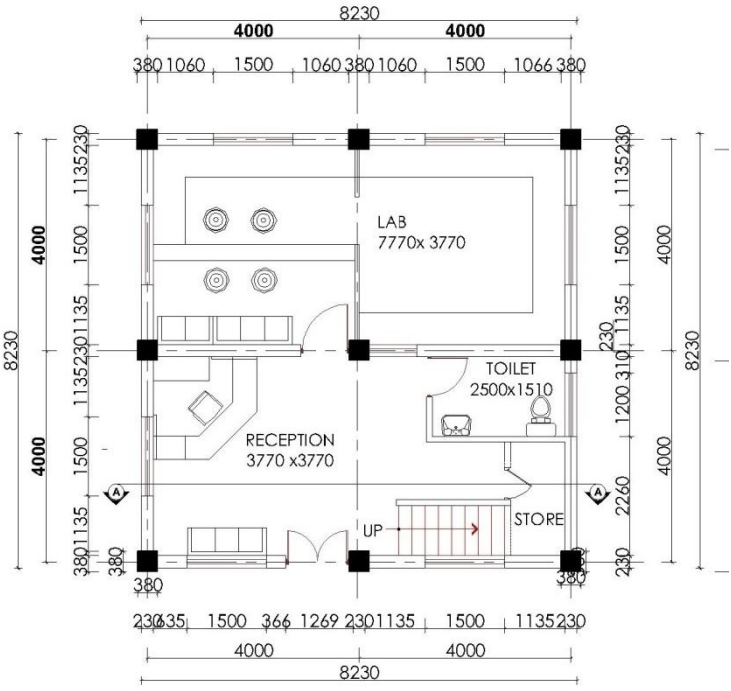

**GROUND FLOOR PLAN**  
**AREA= 67.73 sq. mt**

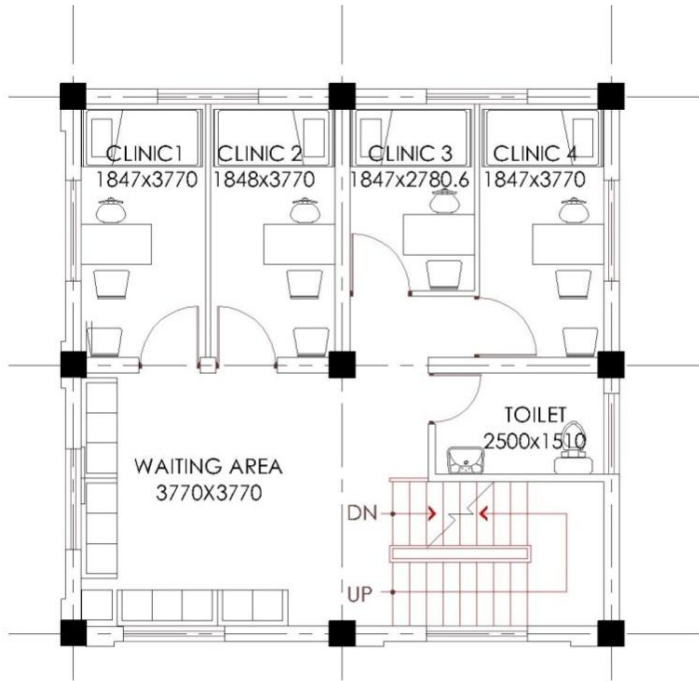

**FIRST FLOOR PLAN**  
**AREA= 67.73 sq. mt**

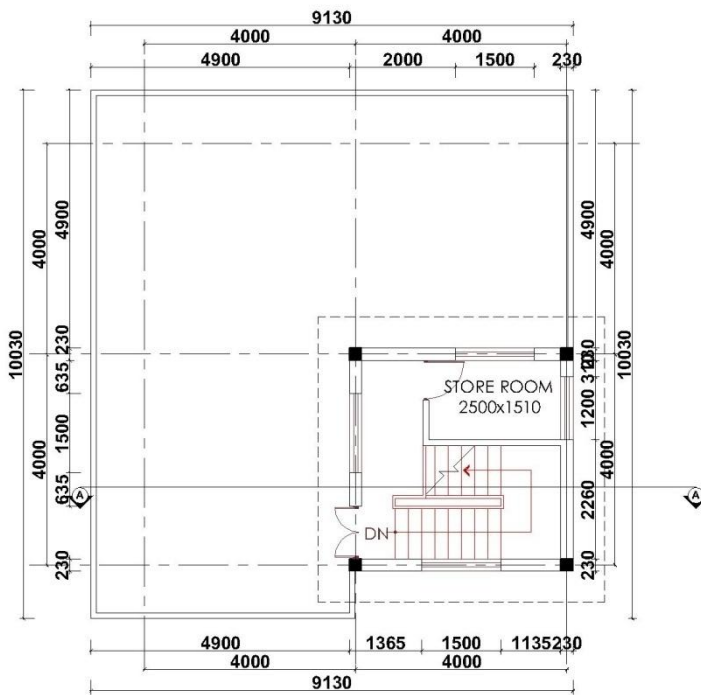

**TOP FLOOR PLAN**

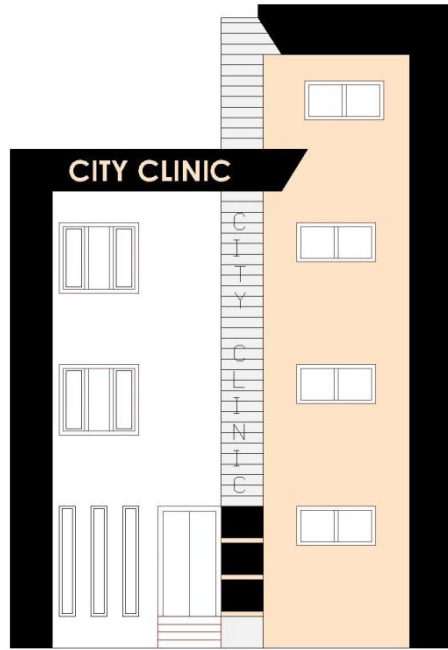

**FRONT ELEVATION**

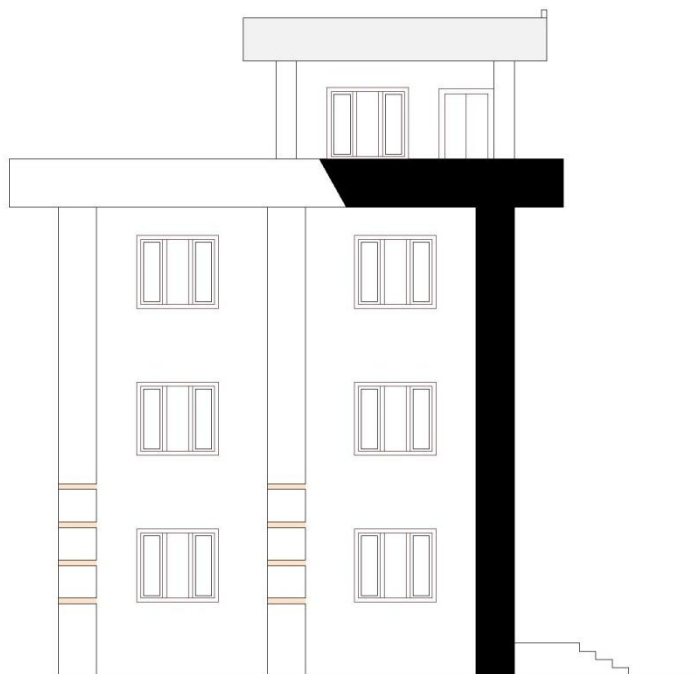

**SIDE ELEVATION**

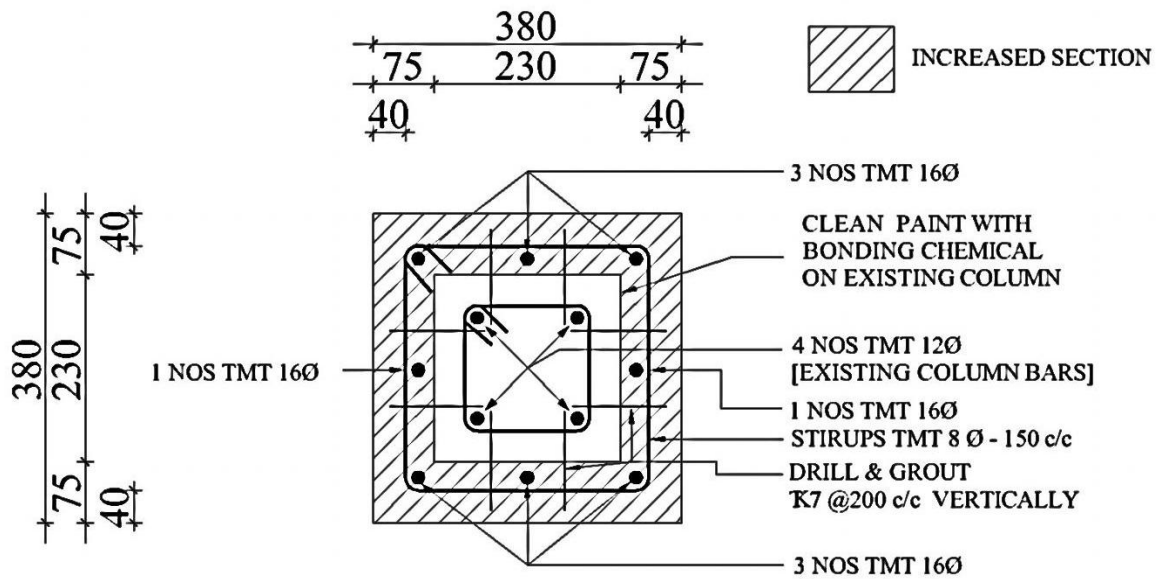

SECTION OF JACKETED COLUMN C1



## IRREGULARITIES IN BUILDINGS WHICH RESTRICT USE OF STATIC PROCEDURE FOR ANALYSIS

Adapted from IS 1893 (Part I) – 2002

**Table 4 Definitions of Irregular Buildings — Plan Irregularities ( Fig. 3 )**  
( Clause 7.1 )

SI No.	Irregularity Type and Description
(1)	(2)
i)	<b>Torsion Irregularity</b> To be considered when floor diaphragms are rigid in their own plan in relation to the vertical structural elements that resist the lateral forces. Torsional irregularity to be considered to exist when the maximum storey drift, computed with design eccentricity, at one end of the structures transverse to an axis is more than 1.2 times the average of the storey drifts at the two ends of the structure
ii)	<b>Re-entrant Corners</b> Plan configurations of a structure and its lateral force resisting system contain re-entrant corners, where both projections of the structure beyond the re-entrant corner are greater than 15 percent of its plan dimension in the given direction
iii)	<b>Diaphragm Discontinuity</b> Diaphragms with abrupt discontinuities or variations in stiffness, including those having cut-out or open areas greater than 50 percent of the gross enclosed diaphragm area, or changes in effective diaphragm stiffness of more than 50 percent from one storey to the next
iv)	<b>Out-of-Plane Offsets</b> Discontinuities in a lateral force resistance path, such as out-of-plane offsets of vertical elements
v)	<b>Non-parallel Systems</b> The vertical elements resisting the lateral force are not parallel to or symmetric about the major orthogonal axes or the lateral force resisting elements

**Table 5 Definition of Irregular Buildings — Vertical Irregularities ( Fig. 4 )**  
( Clause 7.1 )

SI No.	Irregularity Type and Description
(1)	(2)
i)	a) <b>Stiffness Irregularity — Soft Storey</b> A soft storey is one in which the lateral stiffness is less than 70 percent of that in the storey above or less than 80 percent of the average lateral stiffness of the three storeys above b) <b>Stiffness Irregularity — Extreme Soft Storey</b> A extreme soft storey is one in which the lateral stiffness is less than 60 percent of that in the storey above or less than 70 percent of the average stiffness of the three storeys above. For example, buildings on STILTS will fall under this category.

**Table 5 — Concluded**

SI No.	Irregularity Type and Description
(1)	(2)
ii)	<b>Mass Irregularity</b> Mass irregularity shall be considered to exist where the seismic weight of any storey is more than 200 percent of that of its adjacent storeys. The irregularity need not be considered in case of roofs
iii)	<b>Vertical Geometric Irregularity</b> Vertical geometric irregularity shall be considered to exist where the horizontal dimension of the lateral force resisting system in any storey is more than 150 percent of that in its adjacent storey
iv)	<b>In-Plane Discontinuity in Vertical Elements Resisting Lateral Force</b> A in-plane offset of the lateral force resisting elements greater than the length of those elements
v)	<b>Discontinuity in Capacity — Weak Storey</b> A weak storey is one in which the storey lateral strength is less than 80 percent of that in the storey above. The storey lateral strength is the total strength of all seismic force resisting elements sharing the storey shear in the considered direction.

**Table 6 Importance Factors, I**  
( Clause 6.4.2 )

SI No.	Structure	Importance Factor
(1)	(2)	(3)
i)	Important service and community buildings, such as hospitals; schools; monumental structures; emergency buildings like telephone exchange, television stations, radio stations, railway stations, fire station buildings; large community halls like cinemas, assembly halls and subway stations, power stations	1.5
ii)	All other buildings	1.0

NOTES

- 1 The design engineer may choose values of importance factor *I* greater than those mentioned above.
- 2 Buildings not covered in SI No. (i) and (ii) above may be designed for higher value of *I*, depending on economy, strategy considerations like multi-storey buildings having several residential units.
- 3 This does not apply to temporary structures like excavations, scaffolding etc of short duration.

Adapted from IS 1893 (Part I) – 2002

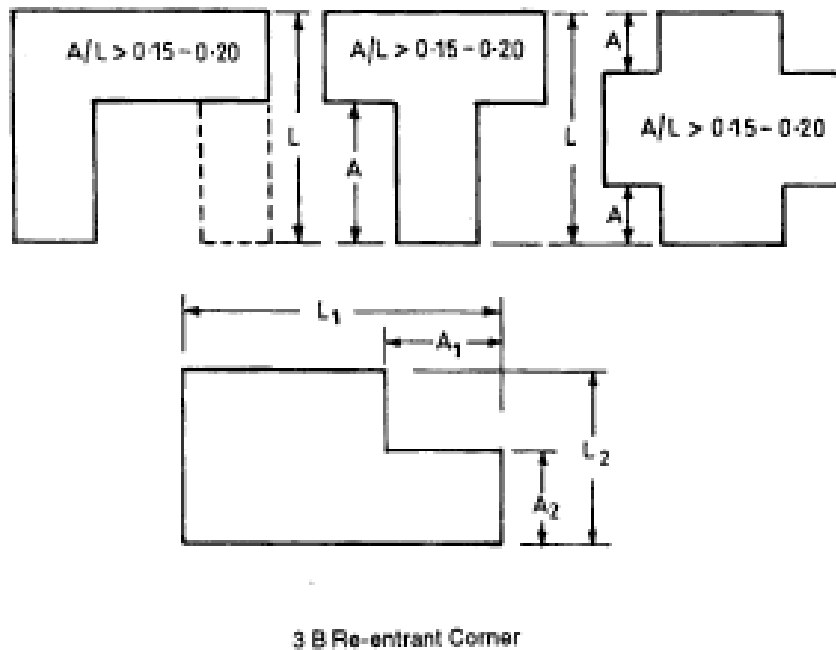
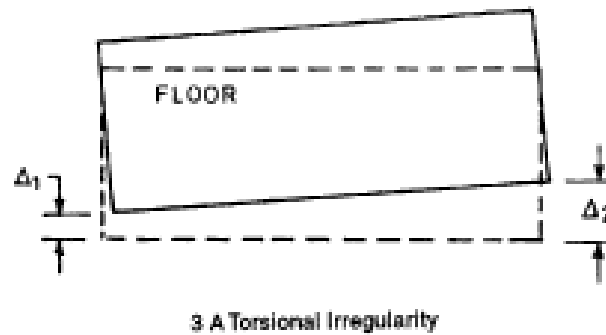
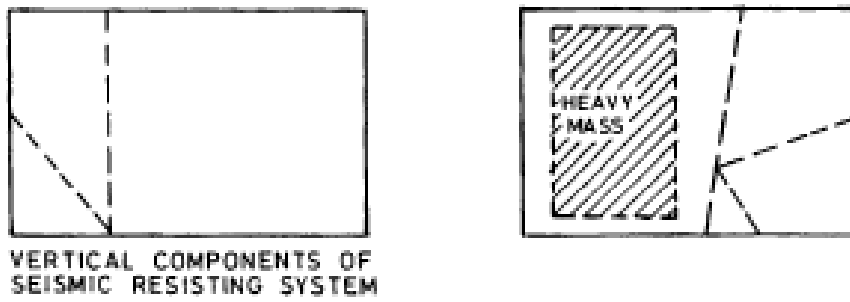
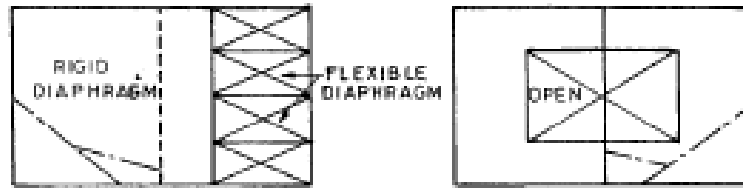

FIG. 3 PLAN IRREGULARITIES — *Continued*

Adapted from IS 1893 (Part I) – 2002

MASS RESISTANCE ECCENTRICITY



VERTICAL COMPONENTS OF SEISMIC RESISTING SYSTEM

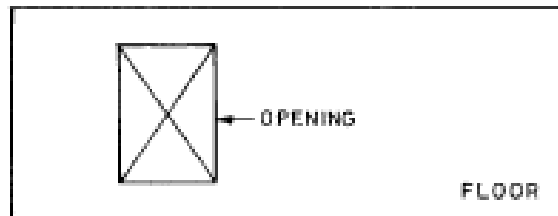

3 C Diaphragm Discontinuity

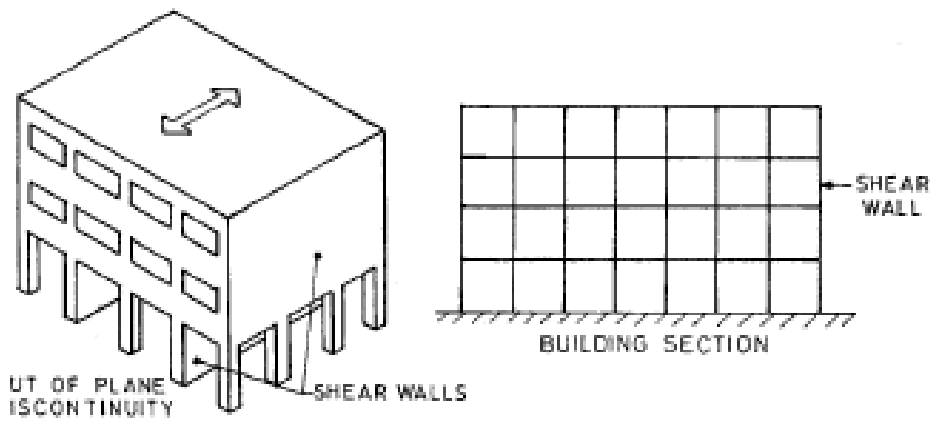

3 D Out-of-Plane Offsets

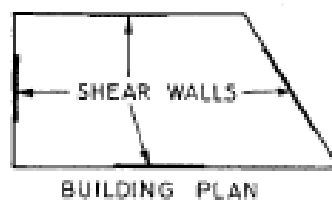

3 E Non-Parallel System

Adapted from IS 1893 (Part I) – 2002

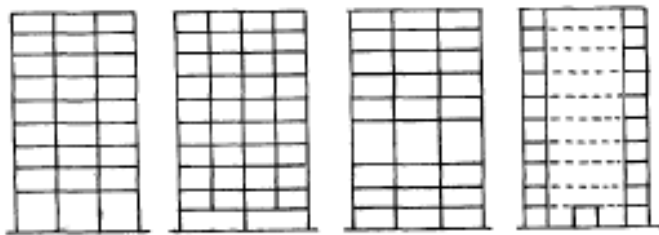

STOREY STIFFNESS  
FOR THE BUILDING

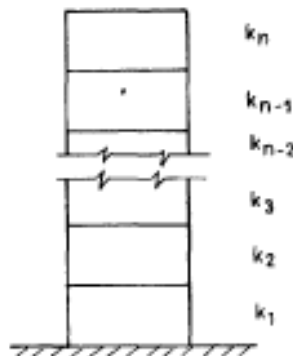

SOFT STOREY WHEN

$$k_i < 0.7 k_{i+1}$$

$$\text{OR } k_i < 0.8 \left( \frac{k_{i+1} + k_{i+2} + k_{i+3}}{3} \right)$$

4 A Stiffness Irregularity

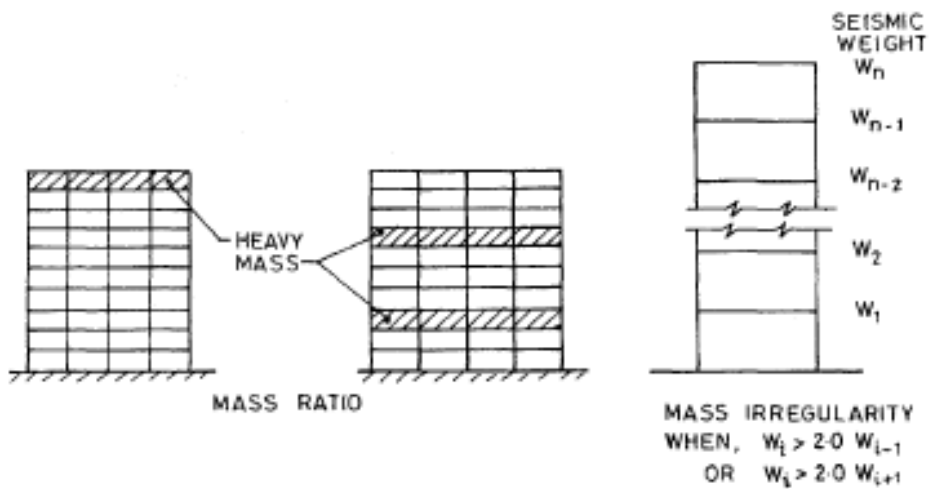

4 B Mass Irregularity

FIG. 4 VERTICAL IRREGULARITIES — Continued

Adapted from IS 1893 (Part I) – 2002

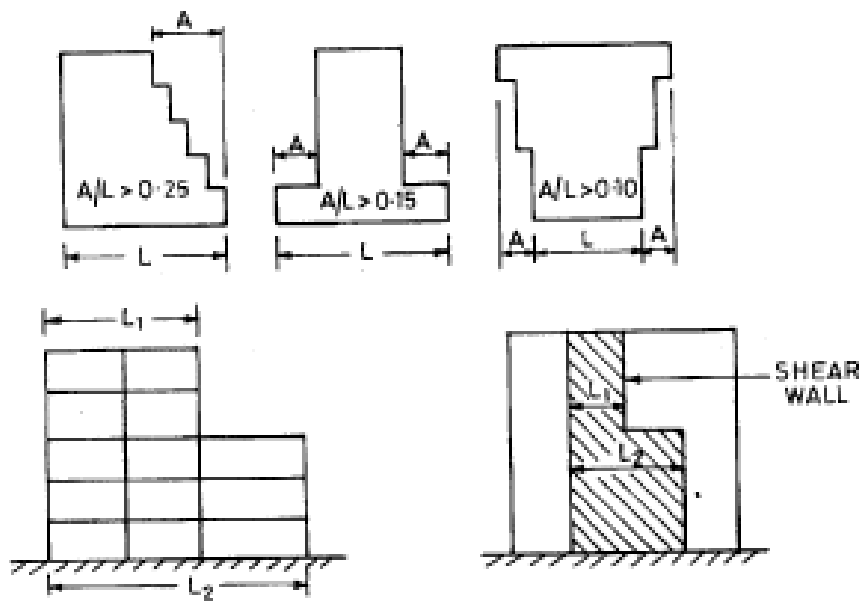

4 C Vertical Geometric Irregularity when  $L_2 > 1.5 L_1$

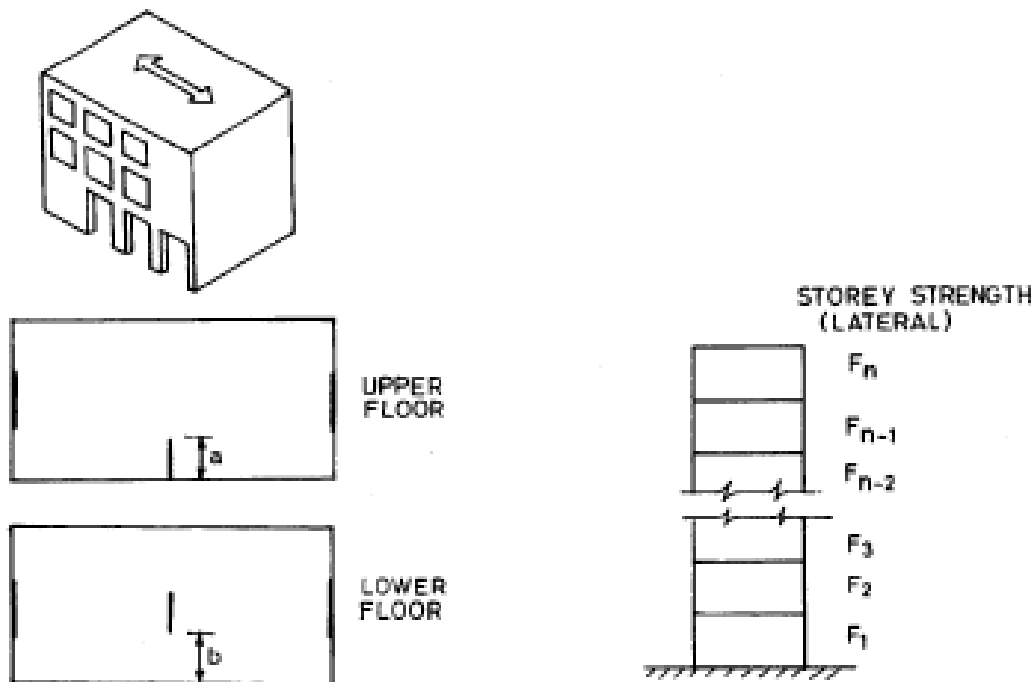

4 D Plane Discontinuity in Vertical Elements Resisting Lateral Force when  $b > a$

4 E Weak Storey when  $F_i < 0.8 F_{i+1}$

FIG. 4 VERTICAL IRREGULARITIES